

Stratagy[®]

Voice Processing Systems

Stratagy Flash, IVP8

User Guide

Publication Information

Toshiba America Information Systems, Inc., Telecommunication Systems Division, reserves the right, without prior notice, to revise this information publication for any reason, including, but not limited to, utilization of new advances in the state of technical arts or to simply change the design of this document.

Further, Toshiba America Information Systems, Inc., Telecommunication Systems Division, also reserves the right, without prior notice, to make such changes in equipment design or components as engineering or manufacturing methods may warrant.

STG-UG-FL/I8-VA
4016217

Version A, June 2002

© Copyright 2002

Toshiba America Information Systems, Inc. Telecommunication Systems Division

All rights reserved. No part of this manual, covered by the copyrights hereon, may be reproduced in any form or by any means—graphic, electronic, or mechanical, including recording, taping, photocopying, or information retrieval systems—without express written permission of the publisher of this material.

Strata is a registered trademark of Toshiba Corporation.

Strategy and Perception are registered trademarks of Toshiba America Information Systems, Inc.

Trademarks, registered trademarks, and service marks are the property of their respective owners.

TOSHIBA AMERICA INFORMATION SYSTEMS, INC. ("TAIS")

Telecommunication Systems Division License Agreement

IMPORTANT: THIS LICENSE AGREEMENT ("AGREEMENT") IS A LEGAL AGREEMENT BETWEEN YOU ("YOU") AND TAIS. CAREFULLY READ THIS LICENSE AGREEMENT. USE OF ANY SOFTWARE OR ANY RELATED INFORMATION (COLLECTIVELY, "SOFTWARE") INSTALLED ON OR SHIPPED WITH A TAIS TELECOMMUNICATION SYSTEM PRODUCT OR OTHERWISE MADE AVAILABLE TO YOU BY TAIS IN WHATEVER FORM OR MEDIA, WILL CONSTITUTE YOUR ACCEPTANCE OF THESE TERMS, UNLESS SEPARATE TERMS ARE PROVIDED BY THE SOFTWARE SUPPLIER. IF YOU DO NOT AGREE WITH THE TERMS OF THIS LICENSE AGREEMENT, DO NOT INSTALL, COPY OR USE THE SOFTWARE AND PROMPTLY RETURN IT TO THE LOCATION FROM WHICH YOU OBTAINED IT IN ACCORDANCE WITH APPLICABLE RETURN POLICIES. EXCEPT AS OTHERWISE AUTHORIZED IN WRITING BY TAIS, THIS SOFTWARE IS LICENSED FOR DISTRIBUTION ONLY TO END-USERS PURSUANT TO THIS LICENSE AGREEMENT.

1. **License Grant.** The Software is not sold; it is licensed upon payment of applicable charges. TAIS grants to you a personal, non-transferable and non-exclusive right to use the copy of the Software provided under this License Agreement. You agree you will not copy the Software except as necessary to use it on one TAIS system at a time at one location. Modifying, translating, renting, copying, distributing, transferring or assigning all or part of the Software, or any rights granted hereunder, to any other persons and removing any proprietary notices, labels or marks from the Software is strictly prohibited; You agree violation of such restrictions will cause irreparable harm to TAIS and provide grounds for injunctive relief, without notice, against You or any other person in possession of the Software. You and any other person whose possession of the software violates this License Agreement shall promptly surrender possession of the Software to TAIS, upon demand. Furthermore, you hereby agree not to create derivative works based on the Software. TAIS reserves the right to terminate this license and to immediately repossess the software in the event that You or any other person violates this License Agreement.
2. **Intellectual Property.** You acknowledge that no title to the intellectual property in the Software is transferred to you. You further acknowledge that title and full ownership rights to the Software will remain the exclusive property of TAIS and/or its suppliers, and you will not acquire any rights to the Software, except the license expressly set forth above. You will not remove or change any proprietary notices contained in or on the Software. The Software is protected under US patent, copyright, trade secret, and/or other proprietary laws, as well as international treaties. Any transfer, use, or copying of the software in violation of the License Agreement constitutes copyright infringement. You are hereby on notice that any transfer, use, or copying of the Software in violation of this License Agreement constitutes a willful infringement of copyright.
3. **No Reverse Engineering.** You agree that you will not attempt, and if you employ employees or engage contractors, you will use your best efforts to prevent your employees and contractors from attempting to reverse compile, reverse engineer, modify, translate or disassemble the Software in whole or in part. Any failure to comply with the above or any other terms and conditions contained herein will result in the automatic termination of this license and the reversion of the rights granted hereunder back to TAIS.
4. **Limited Warranty.** THE SOFTWARE IS PROVIDED "AS IS" WITHOUT WARRANTY OF ANY KIND, TO THE MAXIMUM EXTENT PERMITTED BY APPLICABLE LAW, TAIS AND ITS SUPPLIERS DISCLAIM ALL WARRANTIES WITH REGARD TO THE SOFTWARE, EITHER EXPRESS OR IMPLIED, INCLUDING, BUT NOT LIMITED TO, THE WARRANTY OF NON-INFRINGEMENT OF THIRD PARTY RIGHTS, THE WARRANTY OF YEAR 2000 COMPLIANCE, AND THE IMPLIED WARRANTIES OF MERCHANTABILITY AND FITNESS FOR A PARTICULAR PURPOSE. THE ENTIRE RISK AS TO THE QUALITY AND PERFORMANCE OF THE SOFTWARE IS WITH YOU. NEITHER TAIS NOR ITS SUPPLIERS WARRANT THAT THE FUNCTIONS CONTAINED IN THE SOFTWARE WILL MEET YOUR REQUIREMENTS OR THAT THE OPERATION OF THE SOFTWARE WILL BE UNINTERRUPTED OR ERROR-FREE. HOWEVER, TAIS WARRANTS THAT ANY MEDIA ON WHICH THE SOFTWARE IS FURNISHED IS FREE FROM DEFECTS IN MATERIAL AND WORKMANSHIP UNDER NORMAL USE FOR A PERIOD OF NINETY (90) DAYS FROM THE DATE OF DELIVERY TO YOU.
5. **Limitation of Liability.** TAIS' ENTIRE LIABILITY AND YOUR SOLE AND EXCLUSIVE REMEDY UNDER THIS LICENSE AGREEMENT SHALL BE AT TAIS' OPTION REPLACEMENT OF THE MEDIA OR REFUND OF THE PRICE PAID, TO THE MAXIMUM EXTENT PERMITTED BY APPLICABLE LAW, IN NO EVENT SHALL TAIS OR ITS SUPPLIERS BE LIABLE TO YOU FOR ANY CONSEQUENTIAL, SPECIAL, INCIDENTAL OR INDIRECT DAMAGES FOR PERSONAL INJURY, LOSS OF BUSINESS PROFITS, BUSINESS INTERRUPTION, LOSS OF BUSINESS INFORMATION/DATA, OR ANY OTHER PECUNIARY LOSS OF ANY KIND ARISING OUT OF THE USE OR INABILITY TO USE THE SOFTWARE, EVEN IF TAIS OR ITS SUPPLIER HAS BEEN ADVISED OF THE POSSIBILITY OF SUCH DAMAGES. IN NO EVENT SHALL TAIS OR ITS SUPPLIERS BE LIABLE FOR ANY CLAIM BY A THIRD PARTY.
6. **State/Jurisdiction Laws.** SOME STATES/JURISDICTIONS DO NOT ALLOW THE EXCLUSION OF IMPLIED WARRANTIES OR LIMITATIONS ON HOW LONG AN IMPLIED WARRANTY MAY LAST, OR THE EXCLUSION OR LIMITATION OF INCIDENTAL OR CONSEQUENTIAL DAMAGES, SO SUCH LIMITATIONS OR EXCLUSIONS MAY NOT APPLY TO YOU. THIS LIMITED WARRANTY GIVES YOU SPECIFIC RIGHTS AND YOU MAY ALSO HAVE OTHER RIGHTS WHICH VARY FROM STATE/JURISDICTION TO STATE/JURISDICTION.
7. **Export Laws.** This License Agreement involves products and/or technical data that may be controlled under the United States Export Administration Regulations and may be subject to the approval of the United States Department of Commerce prior to export. Any export, directly or indirectly, in contravention of the United States Export Administration Regulations, or any other applicable law, regulation or order, is prohibited.
8. **Governing Law.** This License Agreement will be governed by the laws of the State of California, United States of America, excluding its conflict of law provisions.
9. **United States Government Restricted Rights.** The Software is provided with Restricted Rights. Use, duplication, or disclosure by the United States Government, its agencies and/or instrumentalities is subject to restrictions as set forth in subparagraph (c)(1)(ii) of The Rights in Technical Data and Computer Software Clause at DFARS 252.227-7013 (October 1988) or subparagraphs (c)(1) and (2) of the Commercial Computer Software - Restricted Rights at 48 CFR 52.227-19, as applicable.

10. **Severability.** If any provision of this License Agreement shall be held to be invalid, illegal or unenforceable, the validity, legality and enforceability of the remaining provisions hereof shall not in any way be affected or impaired.

11. **No Waiver.** No waiver of any breach of any provision of this License Agreement shall constitute a waiver of any prior, concurrent or subsequent breach of the same or any other provisions hereof, and no waiver shall be effective unless made in writing and signed by an authorized representative of the waiving party.

YOU ACKNOWLEDGE THAT YOU HAVE READ THIS LICENSE AGREEMENT AND THAT YOU UNDERSTAND ITS PROVISIONS. YOU AGREE TO BE BOUND BY ITS TERMS AND CONDITIONS. YOU FURTHER AGREE THAT THIS LICENSE AGREEMENT CONTAINS THE COMPLETE AND EXCLUSIVE AGREEMENT BETWEEN YOU AND TAIS AND SUPERSEDES ANY PROPOSAL OR PRIOR AGREEMENT, ORAL OR WRITTEN, OR ANY OTHER COMMUNICATION RELATING TO THE SUBJECT MATTER OF THIS LICENSE AGREEMENT.

Toshiba America Information Systems, Inc.
Telecommunication Systems Division
9740 Irvine Boulevard
Irvine, California 92618-1697
United States of America

TSD 081601

5932

Toshiba America Information Systems, Inc.

Telecommunication Systems Division

Limited Warranty

Toshiba America Information Systems, Inc., (“TAIS”) warrants that this voice processing equipment (except for fuses, lamps, and other consumables) will, upon delivery by TAIS or an authorized TAIS dealer to a retail customer in new condition, be free from defects in material and workmanship for twenty-four (24) months after delivery. This warranty is void (a) if the equipment is used under other than normal use and maintenance conditions, (b) if the equipment is modified or altered, unless the modification or alteration is expressly authorized by TAIS, (c) if the equipment is subject to abuse, neglect, lightning, electrical fault, or accident, (d) if the equipment is repaired by someone other than TAIS or an authorized TAIS dealer, (e) if the equipment’s serial number is defaced or missing, or (f) if the equipment is installed or used in combination or in assembly with products not supplied by TAIS and which are not compatible or are of inferior quality, design, or performance.

The sole obligation of TAIS or Toshiba Corporation under this warranty, or under any other legal obligation with respect to the equipment, is the repair or replacement by TAIS or its authorized dealer of such defective or missing parts as are causing the malfunction with new or refurbished parts (at their option). If TAIS or one of its authorized dealers does not replace or repair such parts, the retail customer’s sole remedy will be a refund of the price charged by TAIS to its dealers for such parts as are proven to be defective, and which are returned to TAIS through one of its authorized dealers within the warranty period and no later than thirty (30) days after such malfunction, whichever first occurs.

Under no circumstances will the retail customer or any user or dealer or other person be entitled to any direct, special, indirect, consequential, or exemplary damages, for breach of contract, tort, or otherwise. Under no circumstances will any such person be entitled to any sum greater than the purchase price paid for the item of equipment that is malfunctioning.

To obtain service under this warranty, the retail customer must bring the malfunction of the machine to the attention of one of TAIS’ authorized dealers within the twenty-four (24) month period and no later than thirty (30) days after such malfunction, whichever first occurs. Failure to bring the malfunction to the attention of an authorized TAIS dealer within the prescribed time results in the customer being not entitled to warranty service.

THERE ARE NO OTHER WARRANTIES FROM EITHER TOSHIBA AMERICA INFORMATION SYSTEMS, INC., OR TOSHIBA CORPORATION WHICH EXTEND BEYOND THE FACE OF THIS WARRANTY. ALL OTHER WARRANTIES, EXPRESS OR IMPLIED, INCLUDING THE WARRANTIES OF MERCHANTABILITY, FITNESS FOR A PARTICULAR PURPOSE, AND FITNESS FOR USE, ARE EXCLUDED.

No TAIS dealer and no person other than an officer of TAIS may extend or modify this warranty. No such modification or extension is effective unless it is in writing and signed by the vice president and general manager, Telecommunication Systems Division.

Contents

Introduction

Organization	v
Conventions	vi
Action/Response Table	vii
Related Documents/Media	vii
Strategy eBrochure and Advisor CD-ROM	viii

Chapter 1 – The Grand Tour

Overview	2
Features to Personalize Your Mailbox	4
Message Queues	4
New Message Queue	4
Saved Message Queue	5
Message Types	6
Forwarded Message	6
Reply Message	6
Greetings	7
Personal	7
System	7
Busy	7
Special Delivery Options	8
Urgent	8
Private	8
Return Receipt	8
Future Delivery	8

Contents

Chapter 2 – Getting Started

Message Destination Selections	9
Personal Distribution Lists	9
System Distribution Lists	10
Directory	10
User Options	10
User Prompts	11
User Tutorial (New User)	11

Chapter 2 – Getting Started

User Tutorial	13
---------------------	----

Chapter 3 – Play Messages

Access Messages	21
Playback Controls	22
Play Your Messages	24
Special Functions	27

Chapter 4 – Send Messages

Recording Controls	32
Send a Message	33
Forward a Message	37
Reply to the Current Message	40
Special Delivery Options	43
Future Delivery	44

Chapter 5 – Manage Mailbox

Change Your Greeting	46
Create or Record Over a Personal Greeting	47
Change Your Greeting Selection	49
Review a Greeting	50
Change Your User Options	51
Change Your Do Not Disturb (DND) Setting	52
Change Your Call Screening Setting	53
Change Your Security Code	54

- Create or Record Over Your Busy Greeting 55
- Select Your Busy Greeting 56
- Record Your Name 57
- Change Your Message Notification 58
- Review Your Option Settings 59
- Manage Your Lists 60
- Manage Guest User IDs 62
- Use Guest User IDs 63

Appendix A – Using Strategy with a Strata CTX

- Call Forward 65
- Message Waiting 67
 - Responding to a Lit Msg LED 67
 - Turning On/Off Message Waiting LED on Another Extension 68
- Call Record to Strategy 68
 - Pause/Resume Recording 69
- Direct Transfer to Voice Mailbox 70
- Voice Mail Conference 70

Appendix B – Using Strategy with a Strata Legacy System

- Call Forward 72
 - Set Call Forward to Strategy 72
 - Cancel Call Forward 76
 - Cancel the Programmed Call Forward Voice Mail Code 76
- Message Retrieval 77

Glossary 79

Index..... 83

Contents

Appendix B – Using Strategy with a Strata Legacy System

Introduction

This guide describes the voice messaging capabilities and procedures for making the Strategy Flash and Strategy IVP8 Voice Processing Systems work for you.

Organization

This guide is divided as follows:

- **Chapter 1 – The Grand Tour** is an overview of the Strategy system. Topics covered are: features to personalize your mailbox; an explanation of message queues, types and destinations; special delivery options; playback/recording controls; and available user options.
- **Chapter 2 – Getting Started** provides instructions on those features you need when accessing Strategy for the first time, including changing your security code and recording your name.
- **Chapter 3 – Play Messages** contains step-by-step instructions on playing messages.
- **Chapter 4 – Send Messages** details how to send, forward, and reply to a message.
- **Chapter 5 – Manage Mailbox** provides step-by-step instructions on recording greetings, using destination (distribution) lists, and activating options such as Do Not Disturb (DND) and Call Screening.
- **Appendix A – Using Strategy with a Strata CTX** outlines Call Forward, Message Waiting, Call Record, Direct Transfer to Voice Mail and Voice Mail Conferencing features.
- **Appendix B – Using Strategy with a Strata Legacy System** explains how to program your Toshiba proprietary telephone for Call Forward and Message Retrieval when using your integrated Strategy system.

- **Glossary** defines frequently-used Strategy voice processing system features and functions.
- **Index**

Conventions

Conventions	Description
Note	Elaborates specific items or references other information. Within some tables, general notes apply to the entire table and numbered notes apply to specific items.
Important!	<i>Calls attention to important instructions or information.</i>
Extension Number	<p>Press to answer a call to the Extension Number. Each station can have multiple extension buttons. Incoming calls ring the extension button(s) from the top down. For example, station 10's extensions ring 10-1 first, then 10-2, 10-3, and 10-4. A station is considered busy when all extensions are being used.</p> <p>Note The naming convention for DKT assignments within Toshiba is Directory Numbers. For clarity and ease of understanding, the terms Extension Number and Phantom Extension Number will be used in this document in lieu of PDN and PhDN.</p>
Arial bold	Represents telephone buttons.
Courier	Shows a computer keyboard entry or screen display.
"Type"	Indicates entry of a string of text.
"Press"	Indicates entry of a single key. For example: Type prog then press Enter .
Plus (+)	Shows a multiple PC keyboard or phone button entry. Entries without spaces between them show a simultaneous entry. Example: Esc+Enter . Entries with spaces between them show a sequential entry. Example: # + 5.

Conventions	Description
Tilde (~)	Means “through.” Example: 350~640 Hz frequency range.
➤	Denotes the step in a one-step procedure.
➤	Denotes a procedure.
See Figure 10	Grey words within the printed text denote cross-references. In the electronic version of this document (Library CD-ROM or FYI Internet download), cross-references appear in blue hypertext.

Action/Response Table

Actions you perform appear in this column. They can consist of either a single step or a series of numbered steps.

The *immediate response to the action* performed appears in this column. Additional notes and comments are also included.

Related Documents/Media

Note Some documents listed here may appear in different versions on the CD-ROM, FYI, or in print. To find the most current version, check the version/date in the Publication Information on the back of the document’s title page.

Important! *Read this User Guide first, then use it with the Quick Reference Guide.*

- Strategy Quick Reference Guide
- Strategy Voice Processing General Description
- Strategy Voice Processing Installation and Maintenance Manual
- Strategy System Administrator Guide
- Strategy Library CD-ROM

For authorized users, Internet site FYI (<http://fyi.tsd.toshiba.com>) contains all current Strategy documentation and enables you to view, print, and download current publications.

Strategy eBrochure and Advisor CD-ROM

Packaged with every Strategy shipped is a CD-ROM containing *Strategy eBrochure*, and an end-user tutorial, *Strategy Advisor*.

eBrochure

The *eBrochure* provides a description of each of the Strategy products along with audio supplemented mini-demonstrations illustrating the capabilities of Strategy voice processing. Also included on the CD-ROM is an electronic copy of this *Strategy General Description*.

Advisor

The *Strategy Advisor* is an end-user tutorial that can be used as a learning tool for the new user or as a refresher course for existing Strategy users.

The *Strategy Advisor* program covers general topics—such as play messages, send messages, etc.—that are applicable to all models of Strategy systems. All presentations interact with the viewer in order to provide a better understanding of how Strategy works.

This chapter provides an overview of the system and covers the following general topics:

- Features to personalize your mailbox
- Message queues
- Message types
- Greetings
- Special delivery options
- Future delivery
- Message destination selections
- User options
- User prompts
- User tutorial (New User)

Overview

Stratagy manages multiple voice processing functions simultaneously 24-hours-a-day, 7-days-a-week. *Your mailbox, referred to as a User ID in Stratagy*, is always available for callers to leave private voice messages. In addition, you can update your greeting at your convenience or send and receive messages from any tone-dialing telephone.

Callers control their own progress through the system. They no longer have to wait for a person to answer the telephone. If your extension is busy or you do not answer, callers can transfer to an operator, call another extension, or record a private, detailed message.

A representative in your company has been assigned as the System Administrator for the system. The System Administrator is responsible for configuring the system and your mailbox to suit your company's needs.

The configuration affects how and which features you can access. Whenever possible, this guide provides information concerning feature exceptions and which features may be configured to work differently.

You can access your mailbox from any tone-dialing telephone using your security code. After you access Stratagy, you hear the number of messages you have in your message queue(s), followed by a prompt from the Main Menu options (see [Figure 1](#)). You can then:

- Listen to your messages
- Send or forward messages
- Reply to messages
- Manage your mailbox (e.g., change your greetings, create distribution lists, etc.)

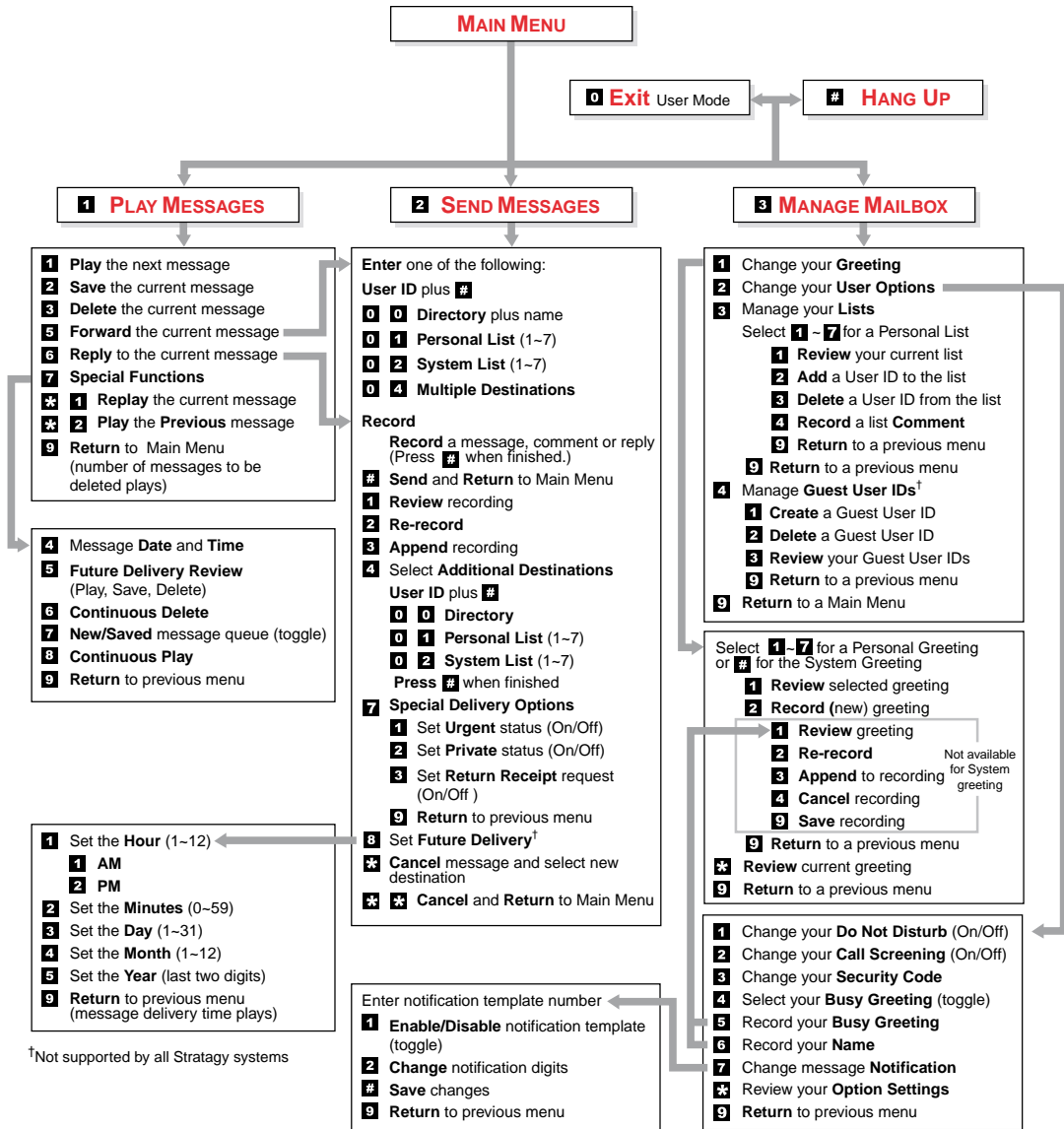

Figure 1 Strategy Main Menu

Features to Personalize Your Mailbox

The Strategy Voice Processing System offers a variety of features to personalize your User ID Mailbox. The following are a few of those features:

- **User ID Mailbox Security Code** – Your User ID mailbox has a security code. The code must be entered by you in order to “log into” your User ID mailbox, giving you access to your messages, settings, greetings, etc. (see [“Change Your Security Code”](#) on page 18).
- **Name Recording** – Your name is announced whenever you log onto your mailbox, the directory is accessed, the system greeting is selected, or when a message is sent by another Strategy user. When you first enter your mailbox, you need to record your name (see [“Record Your Name”](#) on page 16).
- **Personal Greetings** – You can record up to seven personal greetings that are played when you are unavailable (see [“Change Your Greeting”](#) on page 46).
- **Guest Users** – You can create Guest User IDs that can be used by clients, friends, etc. Users frequently use this feature to create guest IDs for clients, so that they may easily exchange confidential information (see [“Manage Guest User IDs”](#) on page 62).

Note The Guest User feature is not supported by all Strategy systems. Check with your System Administrator to find out if your system is configured for this feature.

Message Queues

Your messages reside in one of two queues—new or saved. Messages play in FIFO (First In, First Out) or LIFO (Last In, First Out) order. Ask your System Administrator to find out how your mailbox is configured.

New Message Queue

Messages in the New Message Queue are New or Pending messages.

New messages consist of messages that are unheard or partially heard (less than five seconds). They remain in the queue, the Message Waiting LED remains on, and a Return Receipt is not sent, if applicable, until the message is completely heard.

Messages that you have partially heard (five seconds or longer) are called Pending messages. They remain in the New Message Queue, the Message Waiting LED is turned off, and a Return Receipt is sent, if applicable.

Note The Pending messages feature is available on a mailbox-to-mailbox basis. Check with your System Administrator to find out if your mailbox is configured for this feature.

When you press **1** from the Main Menu to play messages, Stragy automatically accesses the New Message Queue. A new message begins to play based on the type (urgent messages play first) and order received (FIFO/LIFO). If no new messages exist, Stragy automatically accesses the Saved Message Queue. If you are in the Saved Message Queue, you can toggle back to the New Message Queue by pressing **77**.

After you play the last message in the queue, Stragy prompts, “End of messages.” You can choose to return to the top of the queue, go to the top of the other queue, etc.

Saved Message Queue

Saved messages are messages that you saved or that were automatically saved by Stragy at the end of the message.

Access the Saved Message Queue from the Main Menu by pressing **177** or from the New Message Queue by pressing **77**. Stragy automatically accesses the Saved Message Queue when no new messages exist. Saved messages play based on order received (FIFO/LIFO).

After you play the last message in the queue, Stragy prompts, “End of messages.” You can choose to return to the top of the queue, go to the top of the other queue, etc.

Note Ask your System Administrator to find out if your mailbox is configured with one or two (New and Saved) message queue(s).

Message Types

New and Saved Messages can consist of the following special types of messages—forwarded and message reply.

Forwarded Message

Any message sent to you can be forwarded to a single destination or a personal or system distribution list. When forwarding a message, recording a message (comment) is optional.

Reply Message

Messages to which you want to send an immediate answer can be sent as a reply message. When replying to a message, Stratagy does not prompt you to select the destination since it “remembers” the source. The Reply feature only works if the original message is sent from a Stratagy user.

When listening to a reply message, a prompt notifies the user of the name/User ID of the person who sent the reply.

Greetings

You can select either a personal or system greeting to play to callers when you do not answer or when your telephone is busy.

Depending on how your system is configured, callers may hear a separate busy greeting—the system or the custom busy greeting. See [“Change Your User Options”](#) on [page 51](#) for details.

Personal

Personal greetings are greetings that you record for callers. Strategy stores all recorded greetings under the personal greeting number (1~7) for your mailbox. Using the greeting number, you can select the greeting which plays.

The System Administrator can also schedule your greetings to automatically play at different times. If you choose, you can override the automatic schedule using the [“Change Your Greeting Selection”](#) on [page 49](#).

System

The system greeting is a standard prerecorded greeting with all Strategy systems. It cannot be recorded over or deleted. The greeting states, “Please leave a message for (name).” Strategy adds your name from the name recording that you have made (see [“Record Your Name”](#) on [page 16](#)).

Busy

If your User ID mailbox is configured for a personal busy greeting, you can record a custom busy greeting that plays when your extension is busy. If a custom greeting is not recorded, the default system busy greeting plays. See [“Create or Record Over Your Busy Greeting”](#) on [page 55](#) for details.

The custom busy greeting can also be turned on/off using the Select Your Busy Greeting option on the Change Your User Options Menu (see [“Select Your Busy Greeting”](#) on [page 56](#)).

Note The System Administrator must configure your User ID mailbox for the custom busy greeting option to be available.

Special Delivery Options

In addition to recording and sending a new message, you can mark the message urgent, private, or request a return receipt.

Urgent

Messages can be marked urgent by the sender and always play first in the New Message Queue. After the message plays, the urgent status is removed.

Private

Messages can be marked private by the sender. The same options, such as saving and deleting, apply to the private messages; however, a private message cannot be forwarded. Once a message is sent, the private status cannot be removed.

Return Receipt

You can mark a message Return Receipt if you want verification of its receipt. When a user plays (completely or partially) a message marked for Return Receipt, a notification is sent back to the sender. Stratagy notifies the sender when and by whom the message was received and plays the original message.

Future Delivery

Stratagy can be configured so that your message is delivered at a future time and date specified by you. After marking the message for future delivery, you can review (play, save, delete) the message at any time before it is sent.

Note Future Delivery is not supported by all Stratagy systems. Check with your System Administrator to find out if your system is configured for this feature.

Message Destination Selections

At the beginning of the Send Messages menu, you are asked to enter the message destination(s). You can choose to enter a *single* destination (e.g., User ID) or *multiple* destinations (e.g., personal list, User ID, system list). Entering the Multiple Destinations option enables you to address your message to all the recipients at the start of the menu.

You can then record your message and, if desired, add additional destinations when prompted later in the menu. Valid destinations are:

- User ID

Note If you don't know the user's User ID, you can locate the ID on Strategy's system-wide directory by pressing **00**.

- Personal distribution list
- System distribution list
- AMIS local node number
- AMIS Gateway number plus a remote mailbox number

See “[Send a Message](#)” on [page 33](#) for instructions on using these options.

Personal Distribution Lists

You can originate up to seven Personal Distribution Lists consisting of other system users. You can add or delete users at any time. The lists are for only your use.

At the time you create a list, you are given the option of recording a “list comment” that serves as the title or name for the list. The comment plays each time you use the list to confirm that you have chosen the correct distribution list.

Important! Try not to duplicate users on your distribution lists. Strategy does not check for duplicates when you send a message using more than one list. For example, if you select Personal Distribution List #1 and #3 as destinations for your message and User ID 1001 is on both lists, User ID 1001 receives the same message twice.

System Distribution Lists

In addition to Personal Distribution Lists, Strategy supports system-wide distribution lists created by the System Administrator for use by everyone in your company. You should check with your System Administrator to find out which lists are available.

Whenever you enter the list number, the “list comment” for the selected system list plays to confirm that you have chosen the right list.

Directory

You can enter the Dual Tone Multi-frequency (DTMF) digits corresponding to the first few letters of a user’s name and Strategy plays the recorded name (User ID and optionally the extension) that matches the combination of entered digits. You can then select the name or go on to the next name in the directory.

Each User ID can be identified with up to two names. These names are entered into the automated directory by the System Administrator and enhance the directory’s search/find capabilities. Common choices for the names are the first and last names of the user or the last name of the user and a commonly misspelled version of the last name.

User Options

You can set your telephone for Do Not Disturb (DND) or call screening, select or record a busy greeting (plays when your telephone is busy), and designate where or how you are notified of a message.

The following is a brief description of each of the options. Please see [“Change Your User Options”](#) on [page 51](#) for more detailed information.

Important! The System Administrator must activate these features for them to be available.

- **DND** – Strategy automatically sends calls to your User ID (mailbox) without first ringing your telephone.
- **Call Screening** – Strategy asks callers for their name and company. Without the caller’s knowledge, the system relays that information to you. You can decide to receive the call, let the call forward to your mailbox, or transfer the call to another extension with or without an announcement.

- **Busy Greeting** – You can record your own custom busy greeting that plays when callers reach your extension, and it is busy.
- **Message Notification** – Your User ID can have up to 10 notification records programmed by the System Administrator with a specific notification method (message waiting lights, stutter dial tone, pagers, voice, etc.) and the time/day when that notification record applies.

Once you have turned on a specific notification record, Strategy automatically calls you at the designated number and with the chosen method to notify you of your messages.

User Prompts

The Strategy system prompts only for menu options available to you. You do not hear prompts for options:

- Not supported by your Strategy system (e.g., future delivery)
- Not configured for your mailbox by the System Administrator (e.g., guest users, do not disturb).

Check with your System Administrator to verify which user options are available to you.

User Tutorial (New User)

A first time user of Strategy systems automatically hears a user-friendly Strategy tutorial upon logging in to his/her mailbox. The tutorial walks the user through the process of:

- Recording his/her name (if required)
- Recording a personal greeting for the mailbox
- Changing the default security code

Once the Strategy tutorial is completed successfully, it cannot be replayed.

The Grand Tour

User Tutorial (New User)

This chapter instructs you on accessing and exiting your mailbox and outlines the user tutorial steps.

User Tutorial

When you log on to the Strategy Voice Processing system for the very first time, you hear a tutorial that walks you through the following basic steps:

- Record your name (if required). Your name is announced whenever you log onto your mailbox (varies by system), the directory is accessed, the system greeting is selected, or when another Strategy user sends a message to you.
- Record your personal greeting. Your personal greeting automatically plays when you are not available to answer your telephone.
- Change the default security code for your mailbox to ensure privacy. You should change it on a regular basis.

Note If you do not complete the tutorial before hanging up, Strategy saves any completed portion (e.g., your name recording) and restarts where you left off the next time you log on to your mailbox. Once the Strategy tutorial is completed successfully, it cannot be replayed.

Getting Started

Step 1: Access Your Mailbox

Step 1: Access Your Mailbox

The Main Menu (shown below) is your starting point for all of Strategy's messaging features. Pressing **999** from most menus returns you to the Main Menu.

To access your mailbox, you need to know:

- The telephone number to access Strategy
- Your User ID number
- Your default security code

Please ask your System Administrator if you do not have this information.

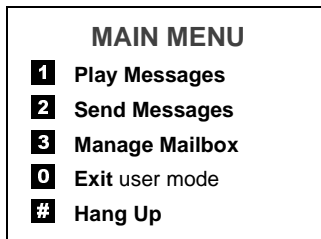

Each time you access your User ID (mailbox), Strategy announces:

- Your name (and extension, if applicable)

Note Some Strategy systems may not be configured to play your name when you log on to your mailbox.

- The number of new and saved messages you have in your message queue(s)
- The number of messages that will be purged upon exiting your mailbox, if applicable

Strategy then plays the Main Menu options.

If you receive new messages while you are logged on to your mailbox, Strategy informs you that you have new messages when you return to the Main Menu.

<p>1. From an internal telephone, call Strategy on _____ ...or from an external telephone, call Strategy on _____.</p>	<p>The system answers with your standard company greeting.</p>
<p>2. When Strategy answers, press *.</p>	<p>Strategy prompts you to enter your User ID.</p>
<p>3. Enter your User ID + #.</p>	<p>If your Strategy system is designed with a fixed length number for your User ID, do not press # after entering a User ID. See your System Administrator for specific operation of your system.</p> <p>Strategy prompts you to enter your security code.</p>
<p>4. Enter the default security code + #.</p> <p>If you make a mistake while entering the code, press * to re-enter.</p>	<p>If your Strategy system is designed with a fixed length number for your security code, do not press # after entering the security code. See your System Administrator for specific operation of your system.</p> <p>You are now in your mailbox. Strategy plays your name and the number of messages you have and then prompts you with a list of choices from the Main Menu.</p>

Step 2: Record Your Name

Your name is announced whenever you log onto your mailbox, the directory is accessed, the system greeting is selected, or when a message is sent by another Stratagy user.

Note Some Stratagy systems may not be configured to play your name when you log on to your mailbox.

When you first enter your mailbox, the Stratagy tutorial prompts you to record your name and walks you through the entire recording sequence. You can re-record your name at any time (see [“Record Your Name”](#) on [page 57](#)).

-
1. At the tone, state your name slowly and clearly (if you like, you can also state your extension).
 2. Press **#** when done.
 3. After your name plays, press:
 - 1** To accept the recording
 - 2** Re-record

Stratagy plays your name recording.

Your recording becomes part of your mailbox and Stratagy prompts you to record your personal greeting.

Stratagy returns you to the record your name prompt.

Step 3: Record Your Personal Greeting(s)

The tutorial now prompts you to record your personal greeting. This greeting becomes your Personal Greeting #1. You can record up to six other greetings (see [“Create or Record Over a Personal Greeting”](#) on [page 47](#) for instructions).

Personal greetings should be informative and advise callers when you will be available to return their calls or respond to their messages. You can update personal greetings as often as you want.

Sample Greeting

“Hi. This is Mary Smith of the Toshiba Marketing Department. It is Monday, June 19, and I am in the office today. I am either on the telephone or have stepped away for a few minutes and your call has been forwarded to my voice mailbox. If at the tone you leave a detailed message and a telephone number where I can reach you, I will be happy to return your call.”

<ol style="list-style-type: none"> 1. At the tone, begin recording your greeting. 2. Press # when done. 3. After your greeting plays, press: <ol style="list-style-type: none"> 1 To accept the recording 2 Re-record 	<p>The following information should be included in your Personal Greeting:</p> <ul style="list-style-type: none"> • Your name • Company and/or department • Date • Your availability • Instructions to leave a detailed message • Call coverage options <p>Strategy plays your greeting.</p> <p>Your greeting becomes Personal Greeting #1 and Strategy prompts you to change your security code.</p> <p>Strategy returns you to the record your greeting prompt.</p>
--	---

Step 4: Change Your Security Code

The tutorial prompts you to change your mailbox’s security code from the preassigned code. You should change your security code on a regular basis thereafter to ensure the privacy of your messages and personal greetings (see [“Change Your Security Code”](#) on page 54).

1. Enter your new security code + #.	The minimum and maximum number of digits for the security code are determined by your System Administrator. Please ask your System Administrator for confirmation on the number.
2. Re-enter your new security code + #.	Stratagy prompts you to re-enter your new security code for verification. After entering the security code a second time, Stratagy announces that your security code has been changed.

You have completed the tutorial. Stratagy announces “mailbox number xxx is enabled,” plays your recorded name and announces the number of messages in your mailbox. You can now perform any of the functions available on the Stratagy Main Menu or exit the mailbox.

Step 5: Exit Your Mailbox or User Mode

- To exit your mailbox, press **#** to hang up from a Toshiba telephone system
...or **999#** to hang up from another manufacturer's telephone system
...or to exit the user mode, press **0**.

When you press **#** to hang up, you hear “Thank you for calling. Good-bye.”

Stratagy can be configured so that you can exit your mailbox without leaving the Stratagy system. Please ask your System Administrator to find out if your system is configured for this or some other function when pressing **0**.

If you have the “0 to EXIT User Mode” capability, you hear Stratagy's company greeting. You can now access another user or a different mailbox.

Getting Started

Step 5: *Exit Your Mailbox or User Mode*

This chapter explains how to use the Play Messages feature. It discusses:

- Access Messages
- Playback Controls
- Play your messages
- Special functions

Depending upon your telephone system and telephone, a message waiting light is lit on your telephone when a voice message has been left for you on the Strategy system.

If configured, Strategy automatically turns off your message waiting light on your telephone when your new message queue is empty or only Pending messages remain (see “[Message Queues](#)” on [page 4](#)). The Message Waiting LED remains on only if there are *new* messages in the queue.

Access Messages

Once you press **1** to play your messages, the following telephone keys assist you in going through your messages:

- 1** Takes you to the next message or back to the top of the queue when you have reached the last message in the queue.
- *1** Replays the current message.
- *2** Takes you to the previous message or back to the last message in the queue when you have reached the top of the message queue.
- 77** Toggles between the New and Saved Message Queues.

If new messages arrive while you are accessing your mailbox, Strategy notifies you that a new message is in the queue upon returning to the Main menu.

Playback Controls

While playing a message, you can pause, control the volume, location, and speed of playback using the following keys (shown below).

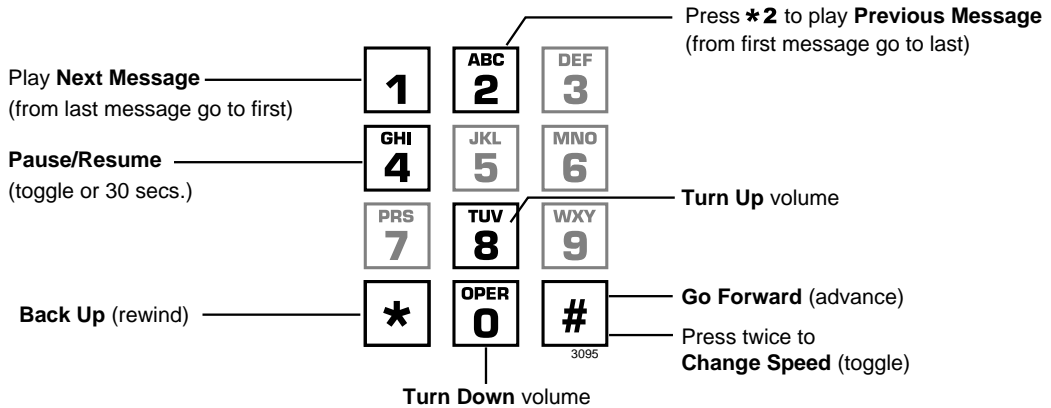

Note Some Strategy systems do not support the following message controls:
8 Turn Up volume, **0 Turn Down** volume, and **## Change Speed** (toggle).
See your System Administrator for specific operation of your system.

1 Play Next Message

Plays next message in queue. If you are at the last message in the queue, goes to the first message in the same queue.

*2 Play Previous Message

Plays previous message in queue. If you are at the first message in the queue, goes to the last message in the same queue.

4 Pause/Resume (toggle or 30 seconds)

At any time while playing messages, you can press **4** to pause the playback for 30 seconds. The message resumes playing as soon as you press **4** or automatically at the end of 30 seconds. You can pause the playback as many times as necessary.

8 Turn Up Volume, 0 Turn Down Volume

Each time you press **8** or **0**, the volume of messages adjusts one increment until the maximum number of increments is reached. Stratagy saves the current level when you exit.

* Back Up (rewind)

The message backs up/rewinds and then begins playing. The default is five seconds (set by the System Administrator).

Go Forward (advance)

The message goes forward/advances and then begins playing. The default is five seconds (set by the System Administrator).

Change Speed (toggle)

Two speeds are available for playing messages: normal and fast (level set for your mailbox by the System Administrator). When you exit the Play Messages Menu, the system returns to the default speed.

Play Your Messages

When you access your mailbox, Strategy tells you the number of urgent, new and saved messages (if supported by your system; check with your System Administrator) you have in your mailbox. If your mailbox is empty, the Strategy prompts do not include “press **1** to play messages.”

When you press **1** from the Main Menu to play messages (menu shown below), Strategy automatically accesses the New Message Queue. If no messages exist in the New Message Queue, Strategy automatically accesses the Saved Message Queue.

From the Main Menu:

- 1** **Play Messages**
 - 1** **Play** the next message
 - 2** **Save** the current message
 - 3** **Delete** the current message
 - 5** **Forward** the current message
 - 6** **Reply** to the current message
 - 7** **Special Functions**
 - 4** Message **Date and Time**
 - 5** **Future Delivery Review** (Play, Save, Delete)
 - 6** **Continuous Delete**
 - 7** **New/Saved** message queue (toggle)
 - 8** **Continuous Play**
 - 9** **Return** to previous menu
 - * 1** **Replay** the current message
 - * 2** **Play** the **Previous** message
 - 9** **Return** to the Main Menu

While playing a message, you can press:

- 4** **Pause/Resume** (toggle or 30 seconds)
- 8** **Turn Up** volume[†]
- 0** **Turn Down** volume[†]
- *** **Backup** (rewind)
- #** **Go Forward** (advance)
- # #** **Change Speed** (toggle)[†]

6232

[†] Not supported by all systems.

1. From the Main Menu, press **1** Play Messages.

While the message plays, you can select **4** pause/resume, **8** turn up volume[†], **0** turn down volume[†], ***** back up (rewind), **#** go forward (advance), **##** change speed[†] (toggle).

[†]not supported by all systems

2. (Optional) While the message plays or immediately after, you can select *one* of the following:
 - 1** Play the next message
 - 2** Save the current message
 - 3** Delete the current message

A message plays.

Once you play a message, Strategy prompts you with the Play Messages Menu until you press **9** to exit the menu or you activate another selection.

Skips to the beginning of the next message.

Note If you reach the end of your messages, pressing **1** takes you back to the top of the same queue.

Saves the current message. The Play Messages Menu plays.

Flags the current message for deletion. The Play Messages Menu plays. When you exit Play Messages, Strategy tells you the number of messages to be deleted. If you do not want to delete a message, save the message before exiting your mailbox.

Note Strategy can be programmed to delete messages after a preset length of time. Consult your System Administrator. Strategy notifies you before purging messages.

Play Messages

Play Your Messages

5 Forward the current message

With the exception of private messages, all messages can be forwarded to a single user, multiple users, or a destination list. See [“Forward a Message”](#) on [page 37](#) for details on this feature.

6 Reply to the current message

Your reply is sent to the originator of the message. In addition, you can send your reply to a single user, multiple users, or a destination list. See [“Reply to the Current Message”](#) on [page 40](#) for details on this feature.

7 Special Functions

Strategy prompts with the options. See [“Special Functions”](#) on [page 27](#) for instructions on using this option.

***1** Replay the current message

The current message plays from the beginning.

***2** Play the previous message

The previous message plays from the beginning.

Note If you are at the top of the message queue, pressing ***2** takes you to the bottom of the same queue.

9 Return to Main Menu

Strategy tells you the total number of messages that will be deleted when you log out of your mailbox, and then returns to the Main Menu.

Special Functions

You can check the date and time a message was sent, or review a message set for future delivery in the Play Messages menu.

When you play a message, this option is available by pressing **7** Special Functions.

Note Some Strategy systems do not support the Future Delivery Review option. See your System Administrator for the specific operation of your system.

► Press an option number:

4 Message Date and Time

The date and time the message was received plays, followed by the entire message.

Note If your System Administrator programmed an automatic date and time stamp for all messages, the stamp plays automatically at the beginning of each message.

5 Future Delivery Review

Strategy plays your name, the future delivery time/date the message will be sent and the entire message. Strategy automatically saves the message for future delivery.

While the message is playing or immediately after, you can select any of the following:

1 Play the next message

Skips to the beginning of the next future delivery message.

2 Save the current message

Saves the current future delivery message.

3 Delete the current message

Flags the current future delivery message for deletion. When you exit the future delivery review, Strategy tells you the number of messages to be deleted. If you do not want to delete a message, save the message before exiting the future delivery review.

9 Return to the Special Functions Menu

6 Continuous Delete

Strategy tells you the total number of messages that will be deleted when you log out of your mailbox, and then returns to the Special Functions Menu.

Deletes multiple messages at one time in your New or Saved Message Queue without additional action from you.

Note See the Continuous Play feature on [page 28](#) before using Continuous Delete.

The number of messages deleted is based on a preset length of time (designated in minutes) set on a system-wide basis by your System Administrator.

Important! *The deletion starts with the first message in the queue and continues until the preset time has expired. Both heard and unheard messages are deleted. If there are two queues—new and saved—the deletion occurs only in the queue you are in when you press **6** for continuous delete.*

Ask your System Administrator to verify that you have this option.

7 New/Saved message queue (toggle)

This feature operates as a toggle; use it to move back and forth between the New and Saved Message Queues.

8 Continuous Play

Plays multiple messages at one time in your New or Saved Message Queue without additional action from you.

The number of messages played is based on a preset length of recorded time (designated in minutes) and therefore varies. (Your System Administrator sets the length of time on a system-wide basis.) The messages played are those whose cumulative time is equal to, or less than, the designated number of minutes.

9 Return to previous
menu

Important! *The playback starts with the first message in the queue and continues until the preset time has expired. If there are two queues—new and saved—the playback occurs only in the queue you are in when you press **8** for continuous playback.*

Ask your System Administrator to verify that you have this option.

Strategy returns to the Play Messages Menu.

Play Messages

Special Functions

From any tone-dialing telephone, you can record and send a message to a user, several users, or to a personal or system distribution list.

This chapter covers:

- Recording controls
- Send a message
- Forward a message
- Reply to the current message
- Special delivery options
- Future delivery

Recording Controls

While recording a message, you can pause/resume the recording or end the recording using the following keys (shown below).

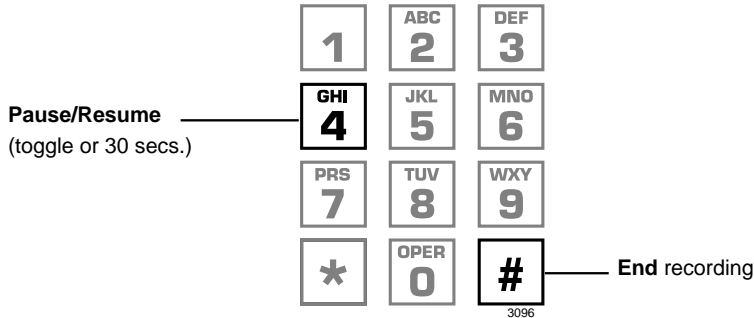

4 Pause/Resume (toggle or 30 seconds)

At any time while recording messages to another mailbox in the system, you can press **4** to pause for 30 seconds. The message resumes recording as soon as you press **4**. Strategy prompts you with, “Begin recording... (Beep).”

If within the 30 seconds you do not press **4**, Strategy restarts another 30-second pause. If during the second 30-second pause you:

- Do not press any key, Strategy assumes you have cancelled the message and returns to the Main Menu.
- Press **#**, Strategy returns you to the Send Messages Menu and you can send, review or record over the message.

End Recording

After recording a message, press **#** to end the recording.

Send a Message

Using the Send Messages Menu (shown below), you can record a message and send it to a single mailbox or multiple destinations (e.g., personal or system distribution list), forward a message (with a comment), or reply to a message sent you.

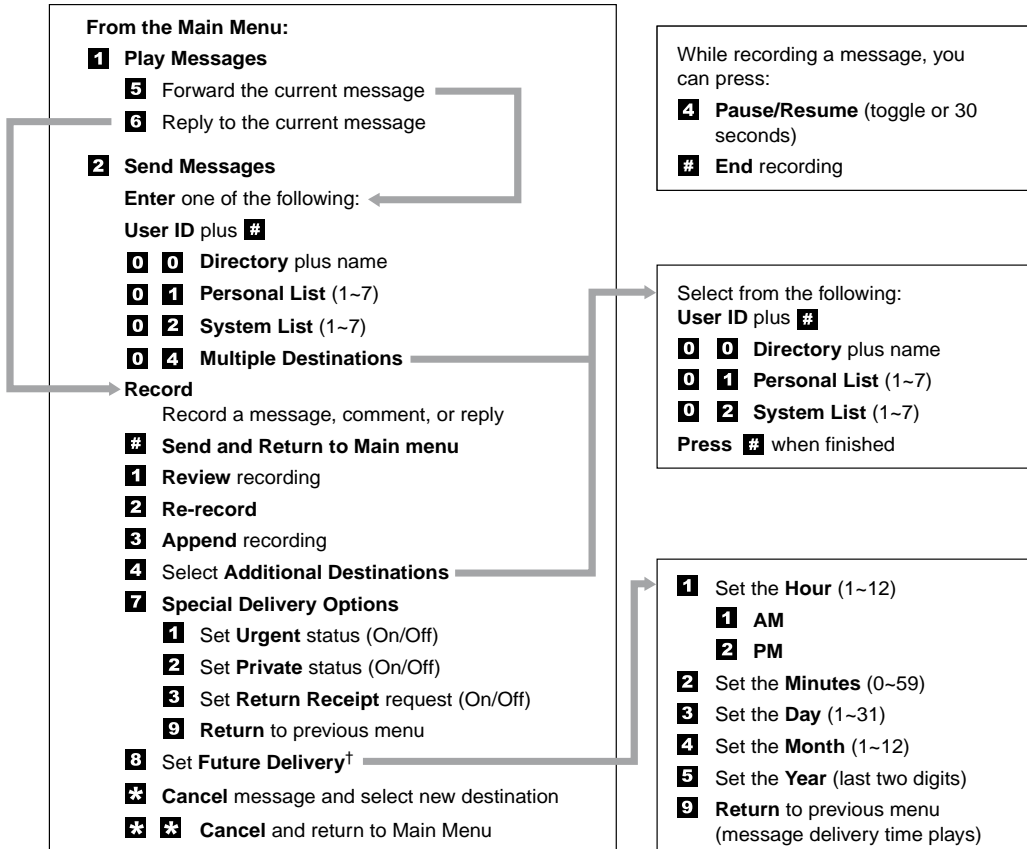

† Not supported by all systems.

Send Messages

Send a Message

1. From the Main Menu, press **2** Send Messages.

2. Enter one of the following destinations:

- User ID and press **#**. Press **#** again to record a message without playing the user's name.

- **00** Directory
Enter the first few letters of the first or last name (Q=7, Z=9).

Press **#** to select the name as the destination

...or **1** to hear the next name

...or ***** to cancel your entry and re-enter.

- **01** Personal List

Enter a list number (**1~7**).

Strategy prompts you to enter the destination (i.e., User ID, Personal, System List, or Multiple Destinations).

Note A message can be sent to a total of 33 destinations, including destinations entered in the **4** Additional Destinations option (see "**4** Select Additional Destinations" on page 35). A list counts as one destination.

Strategy plays the user's name or User ID for confirmation.

Note If your Strategy system is designed with a fixed length number for your User ID, do not press **#** after entering a User ID. See your System Administrator for specific operation of your system.

You are prompted to enter the person's name.

Strategy plays the first name that matches the combination of letters you entered.

You are prompted for the destination list number.

Strategy plays the list comment or number for confirmation. See "**Manage Your Lists**" on page 60 to create or revise a destination (distribution) list.

- **02** System List

Enter a list number
(**1~7**).

- **04** Multiple Destinations

3. Record a message after the tone. When finished, press **#**.

While recording, you can press **4** to pause/resume (toggle or 30 seconds) the recording.

4. Press **#** again to send the message immediately

...or before sending the message, you can use any of the following options:

- 1** Review recording

- 2** Re-record

Press **#** when done.

- 3** Append recording

Press **#** when done.

- 4** Select Additional Destinations

You are prompted for the destination list number.

Stratagy plays the list comment or number for confirmation. Ask your System Administrator for more information about System Lists.

You are prompted for the destinations: **User ID, 00, 01** Personal List and/or **02** System List.

Stratagy tells you that your message has been sent and returns you to the Main Menu.

Important! *If you press **#** to send your message, you cannot use the special recording and sending options.*

The recording plays.

The system prompts you to record at the beep.

The appended recording plays after the already recorded portion of the message. The system prompts you to record at the beep.

Send the message to additional destinations. Valid entries: **User ID, 00, 01** and **02**. You cannot enter **04** Multiple Destinations.

Send Messages

Send a Message

7 Special Delivery Options

You can send a message as urgent, private, or with a return receipt request. The settings can be used in any combination and changed prior to sending the message.

See “[Special Delivery Options](#)” on [page 43](#) for instructions on using this option.

8 Set Future Delivery

You can have your message delivered at a future specified time and date. See “[Future Delivery](#)” on [page 44](#) for instructions on using this option.

***** Cancel message and select new destination

Cancels the message and returns you to [Step 2](#) on [page 34](#).

****** Cancel and Return to the Main Menu

Cancels the message and returns you to the Main Menu.

Forward a Message

Any message sent to you can be forwarded to a single destination or a personal or system distribution list. When forwarding a message, recording a message (comment) is optional.

1. From the Play Messages Menu, press **5** Forward the current message.

2. Enter one of the following destinations:

- **User ID** and press **#**. Press **#** again to record a message without playing the user's name.
- **00 Directory**
Enter the first few letters of the first or last name (Q = 7, Z = 9).
Press **#** to select the name as the destination

...or **1** to hear the next name

...or ***** to cancel your entry and re-enter.

Strategy prompts you to enter the destination (i.e., User ID, Personal, System List or Multiple Destinations).

Note A forwarded message can be sent to a total of 33 destinations, including destinations entered in the **4** Additional Destinations option (see "**4 Select Additional Destinations**" on page 39). A list counts as one destination.

Strategy plays the user's name or User ID for confirmation.

Note If your Strategy system is designed with a fixed length number for your User ID, do not press **#** after entering a User ID. See your System Administrator for specific operation of your system.

You are prompted to enter the person's name.

Strategy plays the first name that matches the combination of the letters you entered.

Send Messages

Forward a Message

- **01** Personal List
Enter a list number (1~7).
 - **02** System List
Enter a list number (1~7).
 - **04** Multiple Destinations
3. (Optional) Record a message (comment) after the tone. When finished, press **#**.
While recording, you can press **4** to pause/resume (toggle or 30 seconds) the recording.
4. Press **#** again to forward the message immediately

...or before sending the message, you can use any of the following options:

- 1** Review recording
- 2** Re-record
Press **#** when done.
- 3** Append recording
Press **#** when done.

You are prompted for the destination list number.

Strategy plays the list comment or number for confirmation. See “[Manage Your Lists](#)” on [page 60](#) to create or revise a destination (distribution) list.

You are prompted for the destination list number.

Strategy plays the list comment or number for confirmation. Ask your System Administrator for more information about System Lists.

You are prompted for the destinations: **User ID, 00, 01** Personal List and/or **02** System List.

Strategy tells you that your message has been forwarded and returns you to the Main Menu.

Important! *If you press **#** to forward your message, you cannot use the special recording and sending options.*

The forwarding comment plays.

The system prompts you to record the comment at the beep.

The appended forwarding comment plays after the already recorded message comment. The system prompts you to record at the beep.

- | | |
|--|--|
| <p>4 Select Additional Destinations</p> <p>7 Special Delivery Options</p>
<p>8 Set Future Delivery</p>
<p>* Cancel message and select new destination</p> <p>**Cancel and Return to the Main Menu</p> | <p>Send the forwarded message to additional destinations. Valid entries: User ID, 00, 01 and 02. You cannot enter 04 Multiple Destinations.</p> <p>You can send a message as urgent, private, or with a return receipt request. The settings can be used in any combination and changed prior to sending the message.</p> <p>See “Special Delivery Options” on page 43 for instructions on using this option.</p> <p>You can have your message delivered at a future specified time and date. See “Future Delivery” on page 44 for instructions on using this option.</p> <p>Cancels the message and returns you to Step 2 on page 37.</p> <p>Cancels the message and returns you to the Main Menu.</p> |
|--|--|

Send Messages

Reply to the Current Message

Reply to the Current Message

Strategy lets you reply to a message that you are currently playing. When you reply to a message, you do not have to select the source of the message as a destination since Strategy “remembers” it. You can send the reply to additional destinations.

When the originator(s) receives and plays the reply, he/she hears the prompt, “Reply message from [name or User ID].”

Important! The Reply feature only works if the original message is sent from a Strategy user. When a Strategy user that has not logged on to his/her mailbox leaves a message for you, you have to enter a destination to respond.

1. From the Play Messages Menu, press **6** Reply to the current message.

2. Record your reply after the tone. When finished, press **#**.

While recording, you can press **4** to pause/resume (toggle or 30 seconds) the recording.

3. Press **#** again to send the reply immediately

...or before sending the reply, you can use any of the following options:

- 1** Review reply
- 2** Re-record

Press **#** when done.

You are prompted to record your reply to the message.

Strategy tells you that your reply has been sent and returns you to the Main Menu.

Important! *If you press **#** to send your reply you cannot use the special recording and sending options.*

The recording plays.

The system prompts you to record your reply at the beep.

3 Append reply

Press **#** when done.

4 Select Additional Destinations

Enter one of the following destinations:

- User ID and press **#**. Press **#** again to record a reply without playing the user's name.

- **00** Directory

Enter the first few letters of the first or last name (Q = 7, Z = 9).

Press **#** to select the name as the destination

...or **1** to hear the next name

...or ***** to cancel your entry and re-enter.

- **01** Personal List

Enter a list number (**1~7**).

The appended reply plays after the already recorded portion. The system prompts you to record at the beep.

Send the message to additional destinations. You may repeat this step as often as necessary.

Stratagy plays the user's name or User ID for confirmation.

Note If your Stratagy system is designed with a fixed length number for your User ID, do not press **#** after entering a User ID. See your System Administrator for specific operation of your system.

You are prompted to enter the person's name.

Stratagy plays the first name that matches the combination of the letters you entered.

You are prompted for the destination list number.

Stratagy plays the list comment or number for confirmation. See "[Manage Your Lists](#)" on [page 60](#) to create or revise a destination (distribution) list.

Send Messages

Reply to the Current Message

- **02** System List
Enter a list number
(**1~7**).

You are prompted for the destination list number.
Strategy plays the list comment or number for confirmation. Ask your System Administrator for more information about System Lists.
- 7** Special Delivery Options

You can send a message as urgent, private, or with a return receipt request. The settings can be used in any combination and changed prior to sending the message.
See “[Special Delivery Options](#)” on [page 43](#) for instructions on using this option.
- 8** Set Future Delivery

You can have your message delivered at a future specified time and date. See “[Future Delivery](#)” on [page 44](#) for instructions on using this option.
- * Cancel reply
Cancels the reply and returns you to [Step 2 on page 40](#).
- **Cancel and Return to the Main Menu
Cancels the message and returns you to the Main Menu.

Special Delivery Options

You can send a message as urgent, private, or with a return receipt request. The settings can be used in any combination and changed prior to sending the message.

When you send, forward or reply to a message, this option is available by pressing **7** Special Delivery Options.

► Enter an option number:

1 Set Urgent status
(toggle)

To remove the urgent
status, press **7** then **1**
again.

2 Set Private status
(toggle)

To remove the private
status, press **7** then **2**
again.

3 Set Return Receipt
request (toggle)

To remove the return
receipt request, press
7 then **3** again.

9 Return to previous
menu

Urgent messages play first in the New Message Queue.

Private messages cannot be forwarded.

Stratagy notifies you when and by whom the message was received and plays the original message.

Note A message that is only partially heard (for five seconds or longer) sends back a return receipt to the sender.

Stratagy returns you to the previous menu.

Future Delivery

Strategy can be configured so that your message is delivered at a future specified time and date. After marking the message for future delivery, you can review (play, save, delete) the message at any time before it is sent. See [Chapter 3 – Play Messages](#) for instructions on using the Future Delivery Review option.

When you send, forward or reply to a message, this option is available by pressing **8** Set Future Delivery. You can choose any or all of the selections.

Note Future Delivery is not supported by all Strategy systems. Check with your System Administrator to find out if your system is configured for this feature.

➤ Enter an option number and press **#**.

1 Set Hour (**1~12**)

1 AM

2 PM

2 Set Minutes (**0~59**)

3 Set Day (**1~31**)

4 Set Month (**1~12**)

5 Set the Year (last two digits)

9 Return to previous menu

Each of these settings default to the current time/date. To set a future delivery time, you do not need to enter all the options. For example, if you have recorded a message and want to have it delivered that afternoon at 2:30 PM, you only need to enter the hour (2), select PM and enter the minutes (30) using options 1 and 2.

Strategy prompts you to select AM or PM.

Two-digit numbers under 80 will be set for the next century. For example, enter **59** to set 2059.

Strategy plays the message delivery time and date and returns you to the previous menu.

Note You can review, continue to send (save), or delete this message using the Future Delivery Review option on the Play Messages Menu. (See [Chapter 3 – Play Messages](#)).

Manage Mailbox

5

Stratagy provides special options to customize and manage your mailbox features (menu shown below).

From the Main Menu:

- 3** **Manage Mailbox**
 - 1** Change your **Greeting**
 - 2** Change your **User Options**
 - 3** Manage your **Lists**
 - 4** Manage your **Guest User IDs**
 - 9** **Return** to Main Menu

Change Your Greeting

You can select either a personal or system greeting to play callers when you do not answer or when your telephone is busy.

This section discusses the three basic greeting controls (menu shown below):

- Create or record over a personal greeting
- Change your greeting selection
- Review a greeting

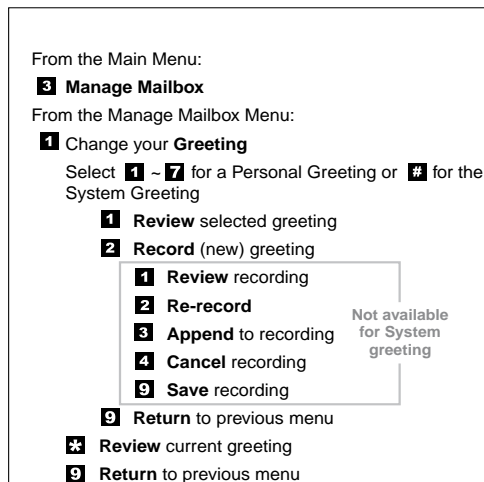

3608

Create or Record Over a Personal Greeting

Personal greetings should be informative and advise callers when you will be available to return their calls or respond to their messages. You can update personal greetings as often as you want. You can store up to seven different recorded greetings from which you can choose as your personal greeting. The System Administrator can also schedule your greetings to play automatically at different times.

1. From the Manage Mailbox Menu, press 1 Change your Greeting.	Strategy prompts with a list of options from the Change your Greeting Menu.
2. Enter a number from 1~7 .	Your greeting is identified by the number chosen. For example, you can record a general greeting as greeting 1, then record a greeting for holidays as greeting 2. Later, you can choose which one plays. You can re-record a greeting at any time.
3. Press 2 to record the greeting (speak slowly and clearly).	The following information should be included in your Personal Greeting: <ul style="list-style-type: none">• Your name• Company and/or department• Date• Your availability• Instructions to leave a detailed message• Call coverage options
4. Press # when done.	

Manage Mailbox

Change Your Greeting

5. (Optional) After recording, you can press:
 - 1 Review recording
 - 2 Re-record
Press # when done.
 - 3 Append recording
Press # when done.
 - 4 Cancel recording
 - 9 Save recording
6. Press 9 to return to the previous menu.
7. Press 1 and select another greeting number (1~7).
8. Repeat [Step 3](#) on [page 47](#).
9. To return to the Main Menu, press 999.

Sample Greeting

“Hi. This is Mary Smith of the Toshiba Marketing Department. It is Monday, June 19, and I am in the office today. I am either on the telephone or have stepped away for a few minutes and your call has been forwarded to my voice mailbox. If at the tone you leave a detailed message and a telephone number where I can reach you, I will be happy to return your call.”

The complete greeting plays.

The system prompts you to record at the beep.

Appending a greeting enables you to add information to the end of your already recorded greeting. The system prompts you to record at the beep.

The greeting is canceled. The system returns to the previous menu.

Strategy tells you that greeting (number) has been recorded and returns to the previous menu. Again, you are given the option to review or record over the greeting you have just recorded.

You are given the option to record another greeting.

Important! *The last greeting selected or recorded is the greeting that callers hear as your User ID greeting.*

Strategy plays the Main Menu options.

Change Your Greeting Selection

- | | |
|---|---|
| <ol style="list-style-type: none">1. From the Main Menu, press 3 Manage Mailbox.2. Press 1 Change your Greeting.3. Enter a personal greeting number (1~7)
...or # to select the system greeting.

...or * to review the current greeting.4. Press 9 to return to the previous menu
...or 99 to return to the Manage Mailbox Menu
...or 999 to return to the Main Menu. | <p>Strategy plays the Manage Mailbox Menu.</p> <p>Strategy prompts with a list of options from the Change Your Greeting Menu.</p> <p>Your callers hear the selected greeting when you do not answer or when your telephone is busy.</p> <p>Your callers hear the system greeting when you do not answer or when your telephone is busy.</p> <p>Note If you have recorded a busy greeting, this greeting does not play when your telephone is busy (see “Create or Record Over Your Busy Greeting” on page 55 for details).</p> <p>Important! <i>The last greeting selected or recorded is the greeting that callers hear as your User ID greeting.</i></p> <p>The current greeting plays.</p> <p>Strategy returns to the previous menu.</p> <p>You can select another user Manage Mailbox option.</p> <p>You can select another Main Menu option.</p> |
|---|---|

Review a Greeting

1. From the Main Menu, press **3** Manage Mailbox.
2. Press **1** Change your Greeting.
3. Press ***** to review the current greeting

...or enter a number from **1~7**, then press **1** to review the greeting. Press **9** to return to previous menu.

4. Press **9** to return to the Manage Mailbox Menu
...or **99** to return to the Main Menu.

Strategy plays the Manage Mailbox Menu.

Strategy plays a list of options from the Change Your Greeting Menu.

The current greeting plays. Strategy prompts you with the Change Your Greeting Menu options.

Note Pressing ***** does not affect the current greeting selection.

The greeting plays. Strategy prompts you with the Change Your Greeting Menu options.

You can select another user Manage Mailbox option.

You can select another Main Menu option.

Change Your User Options

Strategy provides a number of special options to improve time management and productivity (menu shown below). For example, the DND feature can provide blocks of time for meetings or projects uninterrupted by the ringing of a telephone.

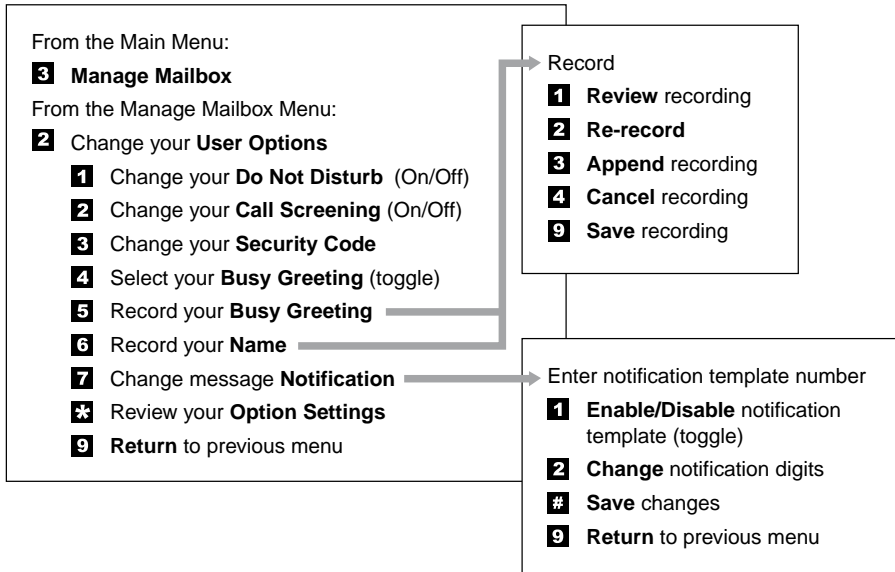

3612

Important! If you do not hear all the options for this menu, they may not be configured for your telephone or system. Please ask your System Administrator to verify which user options are available to you.

Change Your Do Not Disturb (DND) Setting

If you set this feature to on, strategy automatically sends calls to your User ID (mailbox) without first ringing your telephone. The System Administrator can also set this feature to turn on or off automatically at pre-scheduled times and/or days of the week.

1. From the Main Menu, press 3 Manage Mailbox.	Strategy plays the Manage Mailbox Menu.
2. Press 2 Change your User Options.	
3. Press 1 Change your Do Not Disturb (On/Off).	A prompt verifies the current status of the feature.
	Important! <i>DND on the Strategy voice processing system is different from the DND features for your telephone system. If your telephone comes with a DND button or feature, it works independently from this feature on Strategy.</i>
4. (Optional) Press 1 again to reset the feature, if required.	Pressing 1 toggles the DND feature On and Off.
5. Press 9 to return to the Manage Mailbox Menu ...or 99 to return to the Main Menu.	You can select another user Manage Mailbox option. You can select another Main Menu option.

Change Your Call Screening Setting

If you set this feature to on, Strategy asks callers for their name and company. Without the caller's knowledge, the system relays that information to you and provides you with special options to handle the call (menu shown below).

- | |
|--|
| <ol style="list-style-type: none">1 Receive the call2 Reject the call and let the call forward to your mailbox3 Transfer the call to another extension with an announcement4 Transfer the call to another extension without an announcement |
|--|

The System Administrator can also set this feature to turn on or off automatically at pre-scheduled times and/or days of the week.

- | | |
|---|---|
| <ol style="list-style-type: none">1. From the Main Menu, press 3 Manage Mailbox.2. Press 2 Change your User Options.3. Press 2 Change your Call Screening (On/Off).4. (Optional) Press 2 again to reset the feature, if required.5. Press 9 to return to the Manage Mailbox Menu
...or 99 to return to the Main Menu. | <p>Strategy plays the Manage Mailbox options.</p> <p>A prompt verifies the current status of the feature.</p> <p>Pressing 2 toggles the Call Screening feature On and Off.</p> <p>You can select another user Manage Mailbox option.</p> <p>You can select another Main Menu option.</p> |
|---|---|

Change Your Security Code

Each User ID in the system has a security code. The code must be entered by you in order to “log on” to your User ID mailbox, enabling you to access your messages, settings, greetings, etc.

Note You can change your security code as often as you wish to ensure the privacy of your messages and personal greetings.

1. From the Main Menu, press 3 Manage Mailbox.	Strategy prompts with a list of options from the Manage Mailbox Menu.
2. Press 2 Change your User Options.	Strategy prompts with a list of options from the Change your User Options Menu.
3. Press 3 Change your Security Code.	Strategy prompts you to enter your new security code.
4. Enter your new security code + # .	The minimum and maximum number of digits for the security code are determined by your System Administrator. Please ask your System Administrator for confirmation on the number. Strategy prompts you to re-enter your new security code for verification.
5. Re-enter your new security code + # .	After entering the security code a second time, Strategy announces that your security code has been changed.

Create or Record Over Your Busy Greeting

You can record your own custom busy greeting that plays when callers reach your extension and it is busy. While your callers are listening to the busy greeting, they can enter a different User ID, press * to hold (if configured for your mailbox by the System Administrator), or remain on the line to leave a message.

Note Depending on the configuration of your telephone and telephone system, Strategy may not receive a busy tone when callers reach your extension. If Strategy doesn't receive a busy tone, your selected personal greeting plays instead.

If a custom greeting is not recorded, the default system busy greeting plays.

1. From the Main Menu, press 3 Manage Mailbox.	Strategy plays the Manage Mailbox options.
2. Press 2 Change your User Options.	
3. Press 5 Record your Busy Greeting.	Strategy prompts you to record your custom busy greeting.
4. Begin recording at the tone. Press # when done.	
5. (Optional) After recording, you can press:	
1 Review greeting	The complete greeting plays.
2 Re-record	The system prompts you to record at the beep.
Press # when done.	
3 Append recording	The system prompts you to record at the beep. The appended greeting plays after the already recorded portion of the greeting.
Press # when done.	
4 Cancel recording	The greeting is canceled. The system returns to the previous menu.
9 Save recording	Strategy tells you that the greeting has been saved and returns to the previous menu.

Manage Mailbox

Change Your User Options

6. Press **9** to return to the Manage Mailbox Menu
...or **99** to return to the Main Menu.

You can select another user Manage Mailbox option.

You can select another Main Menu option.

Select Your Busy Greeting

1. From the Main Menu, press **3** Manage Mailbox.
2. Press **2** Change your User Options.
3. Press **4** Select your Busy Greeting (toggle).
4. (Optional) Press **4** again to reset the feature, if required.
5. Press **9** to return to the Manage Mailbox Menu
...or **99** to return to the Main Menu.

Strategy plays the Manage Mailbox options.

A prompt verifies the current status of the feature.

Pressing **4** toggles between selecting your custom busy greeting and the system busy greeting.

You can select another user Manage Mailbox option.

You can select another Main Menu option.

Record Your Name

Your name is announced whenever you log onto your mailbox, the directory is accessed, the system greeting is selected, or when a message is sent by another Strategy user.

Strategy prompts you through the entire recording sequence. You can re-record your name at any time simply by repeating these steps.

Notes

- Some Strategy systems may not be configured to play your name when you log on to your mailbox.
- Your system may be programmed such that you need to record your extension as well as your name. Ask your System Administrator for the requirements of your system.

1. From the Manage Mailbox Menu, press 2 Change your User Options.	Strategy prompts with Change your User Options Menu.
2. Press 6 Record your Name.	Strategy prompts you to record your name.
3. At the tone, state your name slowly and clearly (and your extension, if required). Press # when done.	
4. (Optional) After recording, you can press: 1 Review recording 2 Re-record Press # when done.	Your newly recorded name (and extension) plays. You can re-record your name (and extension) as often as you wish.

Manage Mailbox

Change Your User Options

- | | |
|--|---|
| <p>3 Append recording
Press # when done.</p> <p>4 Cancel recording</p> <p>9 Save recording</p> | <p>You can add a short comment that plays at the end of the recording (for example, a vacation announcement).</p> <p>You can cancel your newly recorded name (and extension) and return to the previous menu.</p> <p>Strategy confirms that your name (and extension) has been recorded and returns to the previous menu.</p> |
|--|---|

Change Your Message Notification

Your User ID can have up to 10 notification records programmed by the System Administrator with a specific notification method (message waiting lights, pagers, voice, etc.) and the time/day when that notification record applies. The repeat count (how many times the notification is attempted) and interval for retrying the notification is also set.

Once you have turned on the notification record numbers, Strategy automatically calls you at the designated number and with the chosen notification method.

Using the Change Message Notification option, you can enable/disable a notification method and/or change the notify phone number.

- | | |
|---|---|
| <ol style="list-style-type: none">1. From the Main Menu, press 3 Manage Mailbox.2. Press 2 Change your User Options.3. Press 7 Change message Notification.4. Enter the notification template number (1~10). | <p>Strategy plays the Manage Mailbox options.</p>

<p>Strategy confirms the template number, spells the template title, states whether the template is enabled or disabled, and tells you the phone number (if applicable).</p> <p>Note To select the correct notification template, you need to keep a written record of the template number and function for each template you will be changing.</p> |
|---|---|

5. Press an option number:

1 Enable/disable notification template (toggle)

2 Change notification digits. Enter the new notification telephone number's digits and press **#**.

Save changes

9 Return to previous menu

6. Press **9** to return to the Manage Mailbox Menu
...or **99** to return to the Main Menu.

Pressing **1** toggles the notification template between Enable and Disable. After pressing **1**, a prompt verifies the current status.

Strategy verifies the telephone number entered.

Strategy tells you that the notification template changes have been saved. Strategy returns to the previous menu.

Strategy cancels the change message notification options and returns to the previous menu.

You can select another user Manage Mailbox option.

You can select another Main Menu option.

Review Your Option Settings

1. From the Main Menu, press **3** Manage Mailbox.

2. Press **2** Change your User Options.

3. Press ***** to Review your Option Settings.

4. Press **9** to return to the Manage Mailbox Menu
...or **99** to return to the Main Menu.

Strategy plays the Manage Mailbox options.

Strategy verifies the status of your DND, Call Screening options and plays your selected busy message and name recording.

You can select another user Manage Mailbox option.

You can select another Main Menu option.

Manage Your Lists

Strategy provides the ability to create and manage up to seven personal distribution lists. The lists consist of the User IDs to which you most frequently send messages.

At the time you create a list, you are given the option of recording a “list comment” that serves as a title or name for the list. The comment plays each time you use the list to confirm that you have chosen the correct distribution list.

From the Manage Your Lists Menu (shown below), you can review the list contents, add and delete User IDs to the list, and record a list comment to help you identify the list.

From the Main Menu:

- 3** **Manage Mailbox**

From the Manage Mailbox Menu:

- 3** **Manage your Lists**

Select **1~7** for a Personal List

- 1** **Review** your current list
- 2** **Add** a User ID to the list
- 3** **Delete** a User ID from the list
- 4** **Record** a list **Comment**
- 9** **Return** to previous menu

9 **Return** to previous menu

1. From the Main Menu, press **3** Manage Mailbox.
2. Press **3** Manage your Lists.
3. Select the desired list number **1~7**.

Strategy plays the Manage Mailbox Menu.

You are prompted to enter an option.

4. After selecting a list, you can press:

1 Review your current list

The system prompts you with the name (and extension) of each User ID on the list.

2 Add a User ID to the list

Strategy prompts you to enter the User ID.

Enter the User ID.
Press **#** when done.

The name (and extension) plays. You can add additional User IDs as needed.

3 Delete a User ID from the list

Strategy prompts you to enter the User ID.

Enter the User ID.
Press **#** when done.

The name (and extension) plays. The system prompts “Deleted.”

4 Record a list Comment

When sending a message, the comment plays each time the destination list is selected. Strategy prompts you to record the comment.

Record your comment. Press **#** when done.

5. Press **9** to return to the previous menu

Strategy returns to the previous menu.

...or **99** to return to the Manage Mailbox Menu

You can select another Manage Mailbox option.

...or **999** to return to the Main Menu.

You can select another Main Menu option.

Manage Guest User IDs

Guest User IDs provide limited access to the Strategy system for temporary and project-oriented employees, such as consultants and contractors. Guest users can only send messages to their Host User ID and other guests of their Host User ID.

The Guest User IDs are selected from a system-generated list and assigned on a per-use basis. See your System Administrator for details if you have this feature.

Managing Guest User IDs involves creating and deleting these IDs (menu shown below).

Note Some Strategy systems do not support the Manage Guest User IDs option. See your System Administrator for the specific operation of your system.

From the Main Menu:

- 3** **Manage Mailbox**

From the Manage Mailbox Menu:

- 4** **Manage Guest Mailboxes**
- 1** **Create** a Guest Mailbox
- 2** **Delete** a Guest Mailbox
- 3** **Review** your Guest Mailboxes
- 9** **Return** to previous menu

3498

1. From the Main Menu, press 3 Manage Mailbox.	Strategy plays the Manage Mailbox Menu.
2. Press 4 Manage Guest User IDs.	Strategy plays the Manage Guest User IDs Menu.
3. Select <i>one</i> of the following: 1 Create a Guest User ID	The system prompts with a Guest User ID number. Be sure to make a note of the number and the person you assign.

- | | |
|--|--|
| <p>2 Delete a Guest User ID
Enter the User ID.
Press # when done.</p> <p>3 Review your Guest User IDs</p> <p>4. Press 9 to return to the Manage Mailbox Menu
...or 99 to return to the Main Menu.</p> | <p>Strategy prompts you to enter the User ID.</p> <p>The system confirms the Guest User ID is deleted.</p> <p>The system lists your Guest User ID numbers.</p> <p>You can select another user Manage Mailbox option.</p> <p>You can select another Main Menu option.</p> |
|--|--|

Use Guest User IDs

Instruct your guest users to call the Strategy system and identify themselves as guest users of your mailbox. Only then can they use Strategy to send, receive, and reply to the messages with your mailbox (Host ID) as a typical Strategy user.

Note See [“Access Your Mailbox”](#) on [page 14](#) for more detailed instructions of the following steps.

- | | |
|---|---|
| <p>1. Call the Strategy system.</p> <p>2. Enter 998 + #.</p> <p>3. Enter the Host User ID + #.</p> <p>4. Enter * + the Guest User ID + #.</p> <p>5. Enter the security code + #.</p> | <p>Note Check with your System Administrator for the User ID (default 998) configured for your system.</p> <p>The Host User ID’s greeting plays.</p> <p>Note Strategy uses the combination of the Host User ID and the Guest User ID to identify the caller as your guest.</p> |
|---|---|

Manage Mailbox
Use Guest User IDs

Using Stragy with a Strata CTX

A

This appendix covers the use of Stragy Release 3.3 or higher voice mail with the Strata CTX. Call Forward, Message Waiting, Direct Transfer to Voice Mail and Voice Mail Conference features are all described.

Note Check with your System Administrator about your company's phone system and telephones.

Call Forward

Note See *Strata CTX 3000/2000-series Telephone User Guide* for additional information on programming and using this feature on your phone.

There are two types of Call Forwarding: System and Station.

- System Call Forward (which is set in Programming) automatically directs calls to a predefined location, such as Voice Mail.
- Station Call Forward enables you to assign Call Forward destinations for each extension on your phone. Each extension can be independently set for a different Call Forward feature. You can set a flexible button to perform any Call Forward function.

Call Forward must be set prior to receiving the call.

Note Station Call Forward takes priority over System Call Forward.

[Table 1](#) on [page 66](#) contains the Call Forward Button sequences for performing Call Forward. There are two ways to perform each Call Forward function. One, enter the button sequence as described, or two, program a flexible button to perform the sequence. Refer to the appropriate User Guide for the Call Forward access/cancellation codes or check with your System Administrator.

► To use the Call Forward button sequence

- Follow the instructions in [Table 1](#) below shown under “Button Sequence.” Some features require additional input, such as:
 - **Destination** – If the destination is an outside number, press **#** after entering the destination. The CTX accepts destination numbers of up to 32 digits.
 - **Timer** – This is a two digit entry representing how long (8 to 160 seconds) your telephone should ring before forwarding the call. If you enter one digit, you must press **#** after entering the single digit.

Also, in the following table, (Tone) means that a confirmation tone plays at that point in the sequence.

Table 1 Call Forward Procedures

Feature	Button Sequence
Call Forward - Station	
Call Forward Any Call (Internal and Incoming Line)	
All Call	Press Extension button + #6011 (Tone) + Destination No. (Tone)
Busy	Press Extension button + #6021 (Tone) + Dest. No. (Tone)
No Answer	Press Extension button + #6031 (Tone) + Dest. No. (Tone) + Timer + #
Busy No Answer	Press Extension button + #6041 + Dest. No. + Timer + #
Cancel	Press Extension button + #6051 (Tone)
Call Forward - System	
Call Forward - Incoming Line Calls	
All Calls	Extension button + #6013 (Tone) + Dest. No. (Tone)
Busy	Extension button + #6023 (Tone) + Dest. No. (Tone)
No Answer	Extension button + #6033 + Dest. No. (Tone) + Timer (Tone) + #
Busy No Answer	Extension button + #6043 + Dest. No. (Tone) + Timer (Tone) + #
Cancel	Extension button + #6053 (Tone)
Call Forward - System	
Activate	#620 (Tone)
Cancel	#621 (Tone)

Message Waiting

Use your **Msg** LED/button and LCD to see/retrieve message(s).

An extension can receive up to four simultaneous Message Waiting indications and LCD messages. One message is reserved for the Message Center.

Your phone can be programmed to have up to four additional (flexible) Message Waiting buttons/LEDs. Ask if these buttons have been programmed on your phone. If so, substitute them when the **Msg** button/LED is mentioned in the following steps.

Responding to a Lit Msg LED

1. On an LCD phone, if you see a “+” press **Scroll** to display additional messages; otherwise, go to Step 2. The “+” indicates additional messages. The LCD can show up to three station messages for your extension and three for each additional (phantom) extension that you may have.
2. Press **Msg**, then lift the handset. Your phone rings the extension or voice mail device that sent the indication. The LED continues to flash red.
3. After answering the message(s), place the handset back on-hook.
4. If the Msg LED continues to flash, you have more messages; repeat Steps 1~3 above to retrieve them. Voice mail devices turn off the LED/LCD indications after a short delay, after you checked all messages.
5. To manually turn off your Msg LED, press your extension button, then press **#409**. Do this step for each message received.

Turning On/Off Message Waiting LED on Another Extension

If you call an extension and it's busy or there is no answer, you can light that extension's Message Waiting LED and enable that extension to call you back.

1. Dial an internal extension. You hear busy tone or there's no answer.
2. Press **Msg** or **7**. The Msg LED flashes red on the called phone. At your phone, the Msg LED lights steady red and the LCD shows the station number where you set a Message Waiting light.
3. Press **Spkr**. Your Msg LED turns Off. The Msg LED on the called telephone flashes until the called party presses the flashing **Msg** button - which calls you back.
4. To turn Off a Message LED that you have set on another extension, press **#64** plus the extension number that has the message light set. Then hang up to release your telephone.

Call Record to Strategy

If your company's Strategy is connected to a Toshiba Strata CTX with SMDI integration, you have an additional feature at your disposal—Call Record. While on an active call, a station user can record the conversation and store it in a Strategy voice mailbox. Recordings can also be paused or restarted. Depending upon your System Administrator, you are given either a manual method of recording that allows you to designate the mailbox where the recording will be sent or an auto method that automatically sends the recording to a predefined mailbox that is assigned to the phone you are using. This may be your personal mailbox.

Note Ask your System Administrator which method you need to use when recording a call.

This feature requires the presence of a **Record** and a **PS/RES** (Pause/Resume) button on your telephone. Feature codes are not available. Check with your System Administrator to see if you have access to this feature.

Important! Strategy mailboxes have a definable limit on the length one message can be. If you plan on doing lengthy recordings using this feature, see your System Administrator so your message recording time can be properly defined.

► **To record a call**

1. With a call in progress, press **Record**.

If you are using the *auto method*, the Record LED flashes rapidly and there is approximately a one second interval (in extreme busy conditions, up to five seconds) before the recording starts and the Record LED changes to the in-use interval flash rate. You are now recording. Continue to Step 3.

...or if you are using the *manual method*, the Record LED flashes green rapidly. Continue to Step 2.

2. (Manual method only) If you want to record the call to the predefined mailbox associated with the phone you are using, press **#**. The Record LED flashes rapidly and there is approximately a one second interval (in extreme busy conditions, up to five seconds) before the recording starts and the Record LED changes to the in-use interval flash rate. You are now recording.

...or if you want to record this call to another mailbox, enter the mailbox number (usually the extension number). Finish by pressing **#**. The Record LED flashes rapidly and there is approximately a one second interval (in extreme busy conditions, up to five seconds) before the recording starts and the Record LED changes to the in-use interval flash rate. You are now recording.

3. To stop recording, press **Record**. The LED turns off and the recording stops. To resume recording at this point, you need to begin a new recording, see Step 1.

Pause/Resume Recording

You can pause the recording while continuing the conversation by pressing **PS/RES**. The PS/RES LED flashes red. Your conversation is no longer being recorded.

To resume recording as part of the same message, press the **PS/RES** button again. You can pause and resume indefinitely throughout the conversation. The only limit may be a message length imposed by the Strategy voice mail system.

Direct Transfer to Voice Mailbox

An internal user on the Strata CTX can transfer a call directly to another person's voice mailbox without waiting for the call to forward from the called party's telephone. The voice mailbox does not even need to be associated with an active telephone in the Strata CTX.

Direct Transfer to Voice Mail simplifies getting a call for a busy or absent employee to his/her mailbox. It eliminates the need for the caller to enter the desired mailbox number after being connected to the voice mail system.

► To transfer a call directly to Voice Mail (VM)

1. While on a call, press **Cnf/Trn**. You hear feature dial tone.
2. Enter **#407**. You hear entry tone.
3. Enter the VM mailbox number (usually the same as the extension number), then press **#**. The call transfers immediately and your extension becomes idle. The transferred party hears the greeting associated with the specified mailbox and can then leave a message.

Note See *Strata CTX 3000/2000-series Telephone User Guide* for information on programming this feature on your phone.

Voice Mail Conference

Voice Mail ports may be included in conference calls. This enables all members of the conference to listen to and play voice mail messages.

Using Strategy with a Strata Legacy System

B

Notes

- Strata Legacy systems are Strata DK14, DK40i, DK424i, DK8/16, DK24/56/96. For information on Strata CTX systems, see [Appendix A – Using Strategy with a Strata CTX](#).

Any reference to Strata DK 424i in this appendix, should be read to include DK424 and DK280. Any reference to DK40i should be read to include DK40 and DK16e.

- The naming convention for DKT assignments within Toshiba is Directory Numbers. For clarity and ease of understanding, the terms Extension Number and Phantom Extension Number will be used in this document in lieu of PDN and PhDN.

This appendix explains the procedures for programming Strata Legacy proprietary telephones for Call Forward and Message Retrieval when using a Strategy Voice Processing System.

Once programmed, your Strategy voice processing system can answer calls when you are busy or not available. It can give callers choices when you do not answer, such as: recording a message, dialing another extension, or dialing 0 for assistance.

Note This appendix does not include the procedures for Call Forward and Message Retrieval with a standard telephone. Consult the appropriate Toshiba Standard Telephone User Guide for these instructions.

If you have a Strata telephone system, you need to program your telephone only once for the Call Forward and Message Retrieval functions. Then you can follow the appropriate steps for using Call Forward and Message Retrieval.

Notes

- If you do not have Call Forward keys, you can use access codes instead. Refer to the appropriate User Guide for the Call Forward access/cancellation codes or check with your System Administrator.
- If the Strategy is fully integrated with your telephone system, you may not need to enter a Voice Mail ID code for Call Forwarding or Message Retrieval. Please consult your System Administrator if Voice Mail ID codes are required.
- With most Toshiba proprietary telephones, you can store the sequence of steps on a Speed Dial button for quick access. Refer to the appropriate Quick Reference or User Guide for your telephone for information and instructions on using Speed Dial buttons.

Call Forward

To direct forwarded calls to your mailbox and to ensure that callers receive your personal greeting, additional internal access digits must be programmed initially from your telephone for your extension number and for each phantom extension number by your telephone. These digits are called voice mail ID codes.

Note Your telephone must be the owner of the phantom extension number to store a voice mail ID code for the phantom extension number.

Set Call Forward to Strategy

Skip to “[To forward calls to Strategy](#)” on [page 74](#) if you have already performed this function. Once programmed, this code is automatically sent to the Strategy system whenever calls are forwarded to the Strategy system from your telephone, enabling callers direct access into your mailbox.

► To program the Strategy Voice Mail Code from a Strata DK telephone

- | | |
|--|--|
| 1. Press the extension number or phantom extension number. | You hear a dial tone. |
| 2. For Strata DK424i, DK40i, and DK14, press #656
...or for Strata DK24/56/96 and DK8/16, press 656 . | You hear a confirmation tone. Display telephones show “#656 I.D. CODE SET.”
You have completed programming and hear a confirmation tone. Display telephones show “656 I.D. CODE SET.” |
| 3. Press 91 . | |
| 4. Enter your Strategy mailbox number. | |
| 5. Press Redial . | You hear a confirmation tone. Display telephones show “DATA PROGRAMED.” |
| 6. Press Spkr . | Resets your telephone to the idle condition. |

Notes

- To change the voice mail code, repeat steps.
- In order for the **#** button to function properly while using the Strategy system with a Toshiba Strata system, the **Speed Dial (REP, SDS)** button and the **Redial (RDL)** button must be provided on your Toshiba proprietary telephone.

► To forward calls to Strategy

1. Press the appropriate **Call Forward** button

...or press the extension number or phantom extension number, then enter the appropriate Call Forward access code.

2. Dial the Strategy system number _____.

The Call Forward LED flashes, or you hear a confirmation tone.

You hear a confirmation tone if an access code is dialed. Display telephones show “CALL FORWARD TO.”

Call Forward Access Codes

	Strata DK24/54/96, and DK8/16	Strata DK424i, DK40i, and DK14
Call Forward All Calls	601	#601
Call Forward Busy	602	#602
Call Forward No Answer	603	#603
Call Forward Busy No Answer	604	#604

You hear a confirmation tone.

3. (Optional) For Call Forward-No Answer and Call Forward- Busy/No Answer, you can set the number of seconds that your telephone rings before forwarding.

If you pressed a Call Forward button in Step 1, enter the number of seconds (**08~60**)

...or if you pressed a extension number or phantom extension number in Step 1, press **Speed Dial** and enter the number of seconds (**08~60**).

4. Press the same Call Forward button used in Step 1
...or if you used an access code sequence, press **Redial**, then **Spkr**.

Note Some older telephones do not have **Speed Dial** and **Redial** buttons. You may need to press **SDS** (or **REP**) + the number of seconds (08~60) + **RDL** or * + the number of seconds (08~60) + **#**.

The Call Forward LED lights steady.

Cancel Call Forward

1. Press the appropriate **Call Forward** button, then **Spkr**
...or press the extension number or phantom extension number, then enter the appropriate Call Forward access code.
2. Press **Spkr (SPEAKER)**.

The Call Forward LED turns OFF, or you hear a confirmation tone. Call Forward registration is canceled.

You hear a confirmation dial tone. Display telephones show “CALL FORWARD TO.” Dialing the access code (e.g., **#601**) and no station number cancels any Call Forward type.

See “[To forward calls to Strategy](#)” on [page 74](#) for access codes.

Cancel the Programmed Call Forward Voice Mail Code

1. Press the extension number or phantom extension number.
2. For Strata DK424i, DK40i, and DK14, press **#656**.

...or for Strata DK24/56/96 and DK8/16, press **656**.
3. Press **Redial**.
4. Press **Spkr (SPEAKER)**.

You hear a dial tone.

You hear a confirmation tone. Display telephones show “#656 (or 656) ID CODE SET.”

You will hear a confirmation tone. Display telephones show “DATA PROGRAMED.” The voice mail code is canceled.

Message Retrieval

You can program your **Msg** or phantom extension number/message waiting buttons to automatically retrieve your voice mail messages when you press it.

Skip to “[To retrieve messages with Msg or Phantom Extension Number/Message Waiting button](#)” on [page 78](#) if you have already performed this function. Once programmed, this key does not need to be programmed again.

► To program your **Msg** button to retrieve messages

1. Press the extension number or phantom extension number.

You hear a dial or confirmation tone after you press the button.

2. For Strata DK24/56/96 and DK8/16, press **657**.

You hear a confirmation tone. “657” or “#657” is the Strategy System Identification code for message retrieval from voice mail.

For Strata DK424i/DK424/DK280, DK40i/DK40/DK16e, and DK14, press **#657**.

Your telephone must have the **Speed Dial (REP, SDS)** button and the **Redial (RDL)** button for the **#** button to function properly while using the Strategy system.

3. Press **92** (the Voice Mail ID code for Message Retrieval).
4. Enter your Strategy mailbox number + **#**.
5. Enter your security code + **#**.

By storing your security code, you avoid having to enter your code every time you access your mailbox.

Important! *Including your security code in this programming will enable anyone to retrieve your messages from your phone. If a security code is not desired, do not include it.*

6. Press **Redial**.
7. Press **Spkr**.

You hear a confirmation tone. Display telephones show, “DATA PROGRAMED.”

► To retrieve messages with Msg or Phantom Extension Number/Message Waiting button

- When the Message LED flashes...

For Strata DK424i, DK40i, and DK14, press **Msg** or [Phantom Extension Number/MW]

...or for the Strata DK24/56/96 and DK8/16, press the extension number + **Msg**.

Strategy is called and you are automatically connected to your mailbox.

The system automatically calls Strategy.

Note Pressing **Msg** before the extension number cancels the message waiting notification (e.g., the message light goes Off even though the registered messages may not have been retrieved).

► To cancel automatic retrieval

- For Strata DK424i, DK40i, and DK14, press the extension number or phantom extension number + **#657 + Redial**

...or for the Strata DK24/56/96 and DK8/16, press the extension number or phantom extension number + **657 + Redial**.

Note If you have a Toshiba telephone system, see [Chapter 5 – Manage Mailbox](#) for further instructions on using the Call Forward and Message Retrieval features. If you have one of the telephones listed in that chapter, you may need to program your telephone (once) so that the message waiting key works properly.

Depending upon your telephone system and telephone, a message waiting light is lit on your telephone when a voice message has been left for you on the Strategy system.

If configured, Strategy automatically turns off your message waiting light on your telephone when your new message queue is empty or only partially heard messages remain. All unheard messages must be accessed and partially heard, deleted or saved for Strategy to turn off the message waiting light on your telephone.

Glossary

This glossary defines frequently-used Stratagy voice processing system features and functions.

Term	Definition
Busy Greeting	You can select your custom busy or the system busy greeting for callers to hear when your telephone is busy. If you do not record your custom busy greeting, the system busy greeting automatically plays.
Call Record	In Stratagy systems with software Release 3.3 or higher, you can record a live call into your mailbox from your Strata CTX telephone.
Call Screening	Call Screening operates in on/off mode. When on, Stratagy asks callers for their name and company. Without the caller's knowledge, the system relays that information to you. You can decide to receive the call, let the call forward to your mailbox, or transfer the call to another extension with or without announcement.
Caller	Someone who calls into the Stratagy system. A caller can obtain information, leave a message for someone, and/or provide information.
Called Party	The telephone user the caller reached. See "User."

Glossary

Directory ~ Name Recording

Term	Definition
Directory	A caller enters digits corresponding to the first few letters of a user's name and Strategy plays the recorded name (and optionally extension) that matches the entered digits. Strategy offers the caller the option of selecting the name and being transferred or hearing the next name.
Do Not Disturb (DND)	Do Not Disturb operates in on/off mode. When on, Strategy automatically sends calls to your User ID (mailbox) without ringing your telephone first.
DTMF	Dual Tone Multi-frequency.
Fax Messages	Fax messages sent to your mailbox. With the optional fax mail feature, your mailbox can receive, store, and forward fax messages along with voice messages. When you access your mailbox, Strategy tells you the number of fax messages in your mailbox; and when you play the message, states the number of pages received. You cannot listen to the actual fax information. If you are calling from a fax machine, the fax can be transmitted on the same telephone connection; otherwise, you can direct the fax to a fax machine's number. The system redials the designated fax number and transmits the document.
FIFO (First In, First Out)	Messages play in either FIFO or LIFO order. FIFO plays messages from oldest to newest.
Future Delivery	With future delivery, you can arrange for your message to be delivered at a specific time and date in the future. Once you send the message, you can use the Play Messages—Future Delivery Review option to review, continue to send, or delete the message.
Guest User ID	Guest User IDs provide limited access to the Strategy system for temporary and project-oriented employees, such as consultants and contractors. Guest users can only send messages to their Host User ID and other guests of their Host User ID.
LIFO (Last In, First Out)	Messages play in either LIFO or FIFO order. LIFO plays messages from newest to oldest.
Mailbox (User ID)	See User ID.
Name Recording	Your name (and optionally, extension) recording is used for the directory, system greeting, and User ID.

Term	Definition
New Message Queue	There are two message queues: new and saved. The new message queue contains unheard and partially heard messages. When playing new messages, urgent messages always play first.
Personal Greetings	You may record up to seven personal greetings that are played for callers when you are unavailable. Although only one greeting can be in effect at any one time, you can switch between the greetings by entering the greeting number, or pre-schedule different greetings to play at a certain time and/or day. Greetings can be reviewed or re-recorded. You can also select the default system greeting.
Personal List	You can create/modify up to seven personal destination (distribution) lists of User IDs and record a list comment for identification. When sending messages, you can select a User ID, personal list, system list, and/or the directory as the destination.
Private Messages	You can mark a message "private," meaning the message cannot be forwarded by the recipient to another user. The recipient is told the message has the Private attribute set when listening to his/her messages.
Return Receipt	When sending, forwarding, or replying to a message, you can request a return receipt. Stragy notifies you when and by whom the message was received. The recipient is not notified that receipt verification was requested and cannot circumvent the procedure.
Saved Message Queue	There are two message queues: new and saved. The saved message queue contains messages that you saved or that were automatically saved by the system. Messages flagged to be saved are moved to the saved message queue after you have logged out of your mailbox.
Security Code	Each User ID in the system has a security code. You must enter your security code to access your mailbox. The security code ensures the privacy of your messages, personal greetings, etc.
System Administrator	The representative in your company responsible for configuring the Stragy system and your mailbox to suit you and your companies needs.

Glossary

System Greeting ~ User Notification

Term	Definition
System Greeting	Pre-recorded greeting that adds your recorded name (and extension, if required): "Please leave a message for (name)." Can be used by any user on the Strategy system. Based on your selection, callers hear the system greeting or a personal greeting.
System List	Destination (distribution) list of User IDs created and maintained by the System Administrator. Any user on the Strategy system can use the list. When sending messages, you can choose a User ID, personal list, system list, and/or the directory as the destination.
Tone-dialing Telephone	DTMF push-button tone dialing telephone.
Urgent Messages	Messages are marked Urgent by the sender and by default, are played first, followed by all other messages. The System Administrator can set a notification record to use pager notification exclusively whenever Urgent messages are received.
User	Subscriber of the mailbox, also known as a mailbox user. A user has access to one or more User IDs in the system by knowing the security codes. Once a user accesses his/her User ID, he/she can play back messages, delete those messages, send them to other User IDs, etc.
User ID/User ID Mailboxes	Number for the mailbox user, also known as a voice mailbox. A user mailbox records messages from callers. A user periodically checks the mailbox for messages, etc., or a variety of automatic notification methods can be employed. There is generally one mailbox for each extension, although several mailboxes can share a single extension when multiple users share the same telephone line.
User Notification	Each User ID can have up to 10 notification records set by the System Administrator to automatically call and notify you of messages. You can enable/disable the notify method for each of these records or change the notification telephone number.

Index

A

- about this guide
 - conventions, [vi](#)
 - organization, [v](#)
 - related documents/media, [vii](#)
- access your mailbox, [14](#)

B

- basic functions
 - delete, [25](#)
 - forward, [26](#)
 - play, [25](#)
 - replay current message, [26](#)
 - reply, [26](#)
 - save, [25](#)
- busy greeting, [7](#)
 - record, [55](#)
 - select, [56](#)
- buttons
 - extension, [vi](#)

C

- call forward
 - system, [65](#)
- call record, [68](#)

- call screening, [53](#)
- change
 - security code, [18](#)
 - your greeting, [46](#)
 - your user options, [51](#)
- continuous
 - delete, [28](#)
 - play, [28](#)

D

- destination
 - additional users, [35](#), [39](#), [41](#)
 - directory, [10](#), [34](#), [37](#), [41](#)
 - multiple destinations, [35](#)
 - personal list, [9](#), [34](#), [38](#), [41](#)
 - system list, [10](#), [35](#), [38](#), [42](#)
 - user ID, [34](#), [37](#), [41](#)
- direct transfer to voice mailbox, [70](#)
- directory, [34](#), [37](#), [41](#)
- distribution lists, [9](#), [10](#)
- do not disturb, [52](#)

E

- exit mailbox, [19](#)
- extension number, [vi](#)

F

FIFO, 5

forward message, 6, 26, 37

future delivery, 8

review, 27

setting, 44

G

getting started, 13

greeting

busy, 7, 55, 56

change, 46

personal, 7

change your selection, 49

create, 47

record over, 47

review greeting, 50

sample, 17, 48

system, 7

guest user IDs

manage, 62

use, 63

L

LIFO, 5

lists

manage, 60

personal distribution, 34, 38, 41

system distribution, 35, 38, 42

M

mailbox

access, 14

exit, 19

manage options, 45

personalize, 4

security code, 18

manage

guest user IDs, 62

lists, 60

mailbox, 45

menu

change your user options, 51

greeting, 46

main, 3

manage mailbox, 45

play messages, 24

send messages, 33

message waiting, 67

message waiting light

on [PhDN/MW], 68

on another telephone, 68

messages

additional destinations, 35, 39, 41

append, 35

continuous delete, 28

continuous play, 28

control

back up (rewind), 23

change speed, 23

go forward (advance), 23

pause/resume, 23, 38, 40

play next, 23

play previous, 23

volume, 23

date and time, 27

destination, 9

forward, 6, 26, 37

future delivery, 8, 27, 44

new message queue, 4, 28

- notification, 58
 - play, 21
 - private, 8, 43
 - queues, 4
 - reply, 6, 26, 40
 - re-record, 35
 - return receipt request, 8, 43
 - review recording, 35
 - saved message queue, 5, 28
 - send, 31
 - special delivery options, 8
 - types, 6
 - urgent, 8, 43
- Msg button/LED, 67
- multiple destinations, 35
- ## N
- name
 - recording, 16
 - new/saved messages, 4, 28
 - notification, 58
- ## P
- pause/resume playback, 23, 25, 38, 40
 - pause/resume recording, 32, 35
 - personal
 - distribution list, 34, 38, 41
 - greeting, 7
 - change your selection, 49
 - create, 47
 - record over, 47
 - play messages, 21, 24
 - special functions, 27
 - playback
 - back up (rewind), 23
 - change speed, 23
 - continuous delete, 28
 - continuous play, 28
 - go forward (advance), 23
 - next message, 23
 - pause/resume, 23, 25, 38, 40
 - previous message, 23
 - replay, 26
 - volume, 23
 - playback controls, 22
 - private messages, 8, 43
- ## Q
- queues, 4, 28
- ## R
- record
 - busy greeting, 55
 - controls, 32
 - messages
 - append
 - comment, 38
 - recording, 35
 - reply, 41
 - re-record
 - comment, 38
 - message, 35
 - reply, 40
 - review
 - comment, 38
 - recording, 35
 - reply, 40
 - name, 16
 - pause/resume, 32, 35
 - record to voice mail, 68

reply message, [6](#), [26](#), [40](#)
 additional users, [41](#)
 set future delivery, [44](#)
 special functions, [43](#)
return receipt request, [8](#), [43](#)

S

security code, [13](#)
 change, [18](#)
send messages, [31](#)
special delivery options
 private, [43](#)
 return receipt request, [43](#)
 urgent, [43](#)
special functions, [27](#), [43](#)
 continuous delete, [28](#)
 continuous play, [28](#)
 date/time, [27](#)
 future delivery review, [27](#)
 new/saved queue, [28](#)
Strata DK24/56/96, 8/16 and 280 telephones
 call forward, [72](#)
 message retrieval, [77](#)
system
 distribution list, [35](#), [38](#), [42](#)
 greeting, [7](#)

T

Toshiba telephone systems, [71](#), [78](#)
tutorial, [13](#)
 Stratagy ES Advisor, [viii](#)
 user, [11](#)

U

urgent messages, [8](#), [43](#)
user ID, [15](#), [34](#), [37](#), [41](#)
user options
 busy greeting, [11](#), [55](#)
 busy greeting selection, [56](#)
 call screening, [10](#), [53](#)
 change, [51](#)
 do not disturb, [10](#), [52](#)
 message notification selection, [11](#), [58](#)
user prompts, [11](#)
user tutorial, [11](#), [13](#)

V

voice mail conference, [70](#)
volume control, [23](#), [25](#)